



820/860/880/970/980

Loader Backhoes
Chargeuses Pelleteuses
Caricatore escavatore

Parts Catalogue
Catalogue Pieces
Catalogo componenti

6199042M3

Issue 01

Jan - 06

SECTION M

Wheels and Tyres



General Information
Informations générales
Información general



Operator's Environment
Environnement opérateur
Entorno del operario



Accessories
Accessoires
Accesorios



Electrics
Équipement électrique
Sistema eléctrico



Loader Buckets
Bennes de chargeur
Cucharas de la cargadora



Chassis And Bodywork
Châssis et carrosserie
Chasis y carrocería



Digger Quick Attach
Dispositif de fixation rapide pour bras de pelle
Enganche rápido de la excavadora



Front Axle and Steer System
Essieu avant et direction
Eje delantero y sistema de dirección



Digger Boom and Dipperstick
Flèche et bras de pelle
Aguilón y pluma de la excavadora



Wheels And Tyres
Roues et pneus
Ruedas y neumáticos



Digger Swing System
Système de pivotement de la pelle
Sistema de oscilación de la excavadora



Drive Train and Brakes
Transmission et freins
Transmisión y frenos



Main Hydraulics
Circuit hydraulique principal
Sistema hidráulico principal



Engine and Ancillary Equipment
Moteur et auxiliaires
Motor y equipos auxiliares



Loader
Chargeuse
Cargadora







Legal Requirements
Obligations légales
Requisitos legales

General Information

1 PART NUMBER REFERENCE LIST

(i) EXAMPLE

A	B	C	D	E	F	G	H	J
1	882 782 M91				1	Differential	Differential	Diferencial
2	1885 318 M91	1			1	Kit	Jeu	Juego
3		2		REF.2	1	Crownwheel	Couronne	Corona
4		2		REF.2	1	Pinion	Pignon	Piñón
5	825 776 M1	2		1234567	1	Bolt	Boulon	Perno
6	960 620 M1	2		1234567	1	Bolt	Boulon	Perno

(ii) EXPLANATION

- Col. A Illustration reference number.
 Col. B Part Number.
 Col. C Item also a component of an assembly.
 See assembly illustration number indicated.
 Col. D/E Comment (see symbols and notes).
 Col. F Quantity required (See notes below).
 Col. G, H, J Description - Language format: English, French, Spanish.

(iii) SPECIAL NOTES

The quantity shown in column 'F' is the quantity required for the particular application that is illustrated. Where these parts are components of an assembly, this refers to the quantity in one assembly or sub-assembly.
 For parts such as shims, washers, etc., an 'X' in the quantity column means "Quantity as Required".
 The parts book number, issue number and date are shown in the lower left hand corner of the page. The issue number is printed in brackets.

2 HAND AMENDMENTS

Urgent information is issued in a "change bulletin".
 To make it easy to enter the information in this parts book, the bulletin page will be divided into eight columns.
 Col. A Page number
 Col. B Illustration reference number
 Col. C Part number

- Col. D Change information symbols
 + means 'add the following information'.
 - means 'delete the following information'.
 → means 'amend to read'.
 Col. E An asterisk indicates that the change is due to a printing error.
 Col. F New part number and description.
 Col. G Serial or engine number.
 Col. H Quantity (see previous special notes).

3 RE-ISSUES

When a parts book is completely revised for re-issue, the parts book number suffix will be advanced (e.g. M1 to M2). A revision will incorporate all the change bulletins, plus amendments which have not previously been issued.

4 SAFETY NOTE





When ordering replacement parts to which safety decals were originally attached, the appropriate safety decals must be ordered and fitted.



Informations générales

1 LISTES DES NUMEROS DE REFERENCE DES PIECES

(i) **EXAMPLE**

A	B	C	D	E	F	G	H	J
1	882 782 M91				1	Differential	Differential	Diferencial
2	1885 318 M91	1			1	Kit	Jeu	Juego
3		2		REF.2	1	Crownwheel	Couronne	Corona
4		2		REF.2	1	Pinion	Pignon	Piñón
5	825 776 M1	2		1234567	1	Bolt	Boulon	Perno
6	960 620 M1	2		1234567	1	Bolt	Boulon	Perno

(ii) **EXPLICATIONS**

- Col. A Numéro de référence de l'illustration.
Col. B Numéro de pièce.
Col. C Pièce comprise dans l'ensemble dont le numéro de référence de l'illustration est indiqué.
Col. D/E Remarque (voir symboles et notes).
Col. F Quantité (voir note ci-dessous).
Col. G, H, J Designation ordre des langues: Anglais, Français, Espagnol.

(iii) **NOTES SPECIALES**

La quantité indiquée dans la colonne 'F' est celle applicable à l'ensemble illustré sur la page adjacente, le nombre indique donc la quantité dans l'ensemble ou sous-ensemble et non pour la machine complète.
Pour des pièces telles que cales d'épaisseur, rondelles, etc., un 'X' dans la colonne quantité signifie "suivant besoin".
Le numéro du catalogue, le numéro d'émission et la date sont indiqués dans le coin inférieur de la page. Le numéro d'émission est imprimé entre parenthèses.

2 CORRECTIONS MANUELLES

Les informations urgentes sont émises sur les "Bulletins de Changement" sous forme de corrections manuelles.

Pour faciliter l'entrée de ces informations dans la catalogue, la page du bulletin sera divisée en huit colonnes.

- Col. A Numéro de page.
Col. B Numéro de référence de l'illustration.
Col. C Numéro de pièce.

- Col. D Symboles d'informations de modifications.
+ signifie 'ajouter l'information suivante'.
- signifie 'supprimer l'information suivante'.
→ signifie 'modifier pour lire'.
Col. E Un astérisque indique que la modification est due à une erreur d'impression.
Col. F Nouveau numéro de pièce et désignation.
Col. G Numéro de série machine ou numéro de moteur.
Col. H Quantité (voir notes spéciales sur la page précédente).

3 REEDITONS

Quand un catalogue de pièces de rechange est complètement révisé pour réédition, le suffixe du numéro de catalogue sera avancé (par exemple: M1 à M2), une révision incorporera tous les bulletins de changements ainsi que les modifications non émises précédemment.

4 NOTES DE SECURITE





Lors du remplacement de pièces munies à l'origine d'une décalcomanie de sécurité. La décalcomanie correspondante doit aussi être commandée et montée.



Información general

1 LISTAS CON LOS NUMEROS DE REFERENCIA DE LAS PIEZAS

(i) EJEMPLO

A	B	C	D	E	F	G	H	J
1	882 782 M91				1	Differential	Differential	Diferencial
2	1885 318 M91	1			1	Kit	Jeu	Juego
3		2		REF.2	1	Crownwheel	Couronne	Corona
4		2		REF.2	1	Pinion	Pignon	Piñón
5	825 776 M1	2		1234567	1	Bolt	Boulon	Perno
6	960 620 M1	2		1234567	1	Bolt	Boulon	Perno

(j) EXPLICACIÓN

- Col. A Número de referencia del dibujo.
Col. B Número de pieza.
Col. C Pieza incluida en el conjunto cuyo número de referencia de dibujo se indica.
Col. D/E Comentario (ver los símbolos y las notas).
Col. F Cantidad necesaria (ver nota a continuación).
Col. G, H, J, K Descripción - Formato de idiomas - Inglés, Francés, Alemán, Italiano, Español.

(ii) NOTAS ESPECIALES

La cantidad indicada en la columna 'F' es la cantidad necesaria para el conjunto que figura en la ilustración contigua. El número por lo tanto indica la cantidad pertinente al conjunto o subconjunto y no a la máquina completa.
Para determinadas piezas como espaciadores, arandelas, etc., una X en la columna de cantidades indica "Según Requisitos".
La referencia de número de catálogo y fecha de edición están impresas en el pie de la página. El número de edición está indicado entre paréntesis.

2 CORRECCIONES MANUALES

Las informaciones de carácter urgente serán emitidas en los "boletines de modificación" bajo la forma de correcciones manuales. Para facilitar la inserción de esta información en el catálogo la página del boletín será dividida en ocho columnas.

- Col. A Número de página.
Col. B Número de referencia del dibujo.
Col. C Número de pieza.

- Col. D Símbolos de información de modificación:
+ significa 'añadir la siguiente información'.
- significa 'anular la siguiente información'.
→ significa 'corregir para que diga'.
Col. E Un asterisco indica que la modificación es debida a un error de imprenta.
Col. F Nuevo número de pieza y designación.
Col. G Número de serie de la máquina o número de motor.
Col. H Cantidad (ver notas especiales en páginas precedentes).

3 REEDICIONES

















Cuando un catálogo es revisado en su totalidad para su reedición el sufijo del número de catálogo deberá ser modificado (por ejemplo M1 a M2) una revisión deberá incluir todos los boletines de cambio además de las modificaciones no editadas anteriormente.

4 AVISO DE SEGURIDAD

Cuando se piden piezas de repuesto que originalmente llevaban calcomanías de seguridad hay que pedir y colocar también las calcomanías apropiadas.



Symbols • Symboles • Símbolos

	Right hand	Cote droit	Derecha
	Left hand	Cote gauche	Izquierda
	Width	Largeur	Anchura
	Length	Longueur	Longitud
	Thickness	Epaisseur	Grosor
	Diameter	Diamètre	Diámetro
	Number of teeth/splines	Nombre de dents/cannelures	Número de dientes/estrias
	Top	Haut	Parte superior
	Bottom	Bas	Parte inferior
	From serial or engine number	A partir du numéro de série ou moteur	Desde el número serie o número de motor
	Up to serial or engine number	Jusqu'au numéro de série ou moteur	Hasta el número serie o número de motor
	Repairs and replaces	Répare et remplace	Reemplaza y sustituye
	See page - reference number	Voir page - numéro de référence	Ver página - número de referencia
	Alternative	Alternative	Alternativa
	Not serviced, order	Pas fournies, commander	No suministradas, pedir
	Without or not for... Example:] d [(not for germany)	Sans ou pas pour... Exemple:] D [(Pas pour Allemagne)	Sin o no para... Ejemplo:] D [(No para Alemania)



Symbols • Symboles • Símbolos

D	For Germany only or any text in German only	Pour Allemagne seulement ou en allemand seulement	Para Alemania solamente o cualquier texto en alemán solamente
F	For France only or any text in French only	Pour France seulement ou en français seulement	Para Francia solamente o cualquier texto en francés solamente
I	For Italy only or any text in Italian only	Pour Italie seulement ou en italien seulement	Para Italia solamente o cualquier texto en italiano solamente
GB	For UK. only or any text in English only	Pour le Royaume Uni seulement ou en anglais seulement	Para el Reino Unido solamente o cualquier texto en inglés solamente
E	For Spain or any text in Spanish	Pour Espagne seulement ou espagnol	Para España o cualquier texto en español solamente
NL	For Holland or any text in Dutch	Pour Hollande seulement ou en hollandais	Para Holanda solamente o cualquier texto en holandés solamente
DK	For Denmark or any text in Danish	Pour Danemark seulement ou en danois	Para Dinamarca solamente o cualquier texto en danés solamente
US	For United States of America	Pour les Etats Unis d'Amérique	Para los Estados Unidos de América
N	For Norway or any text in Norwegian	Pour Norvège seulement ou en norvégien	Para Noruega solamente o cualquier texto en noruego solamente
S	For Sweden or any text in Swedish	Pour Suède seulement ou en suédois	Para Suecia solamente o cualquier texto en sueco
P	For Portugal or any text in Portuguese	Pour Portugal seulement ou en portugais	Para Portugal solamente o cualquier texto en portugués solamente



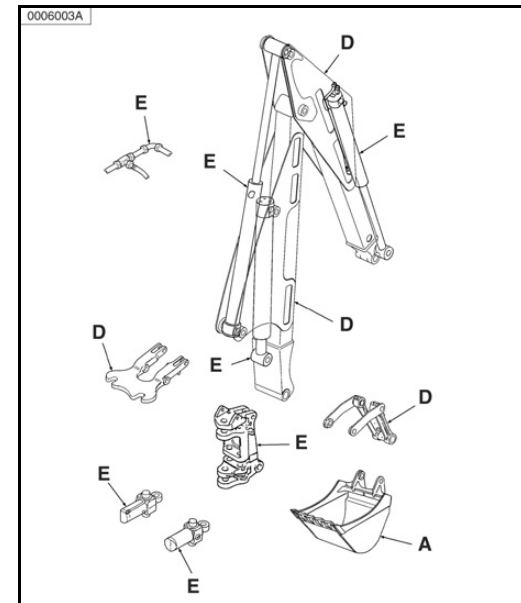
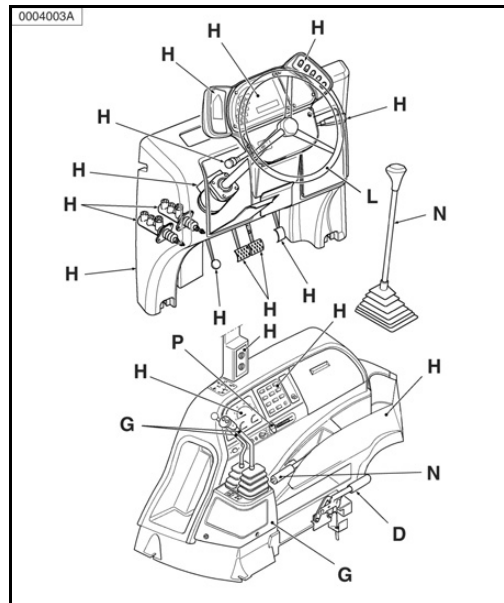
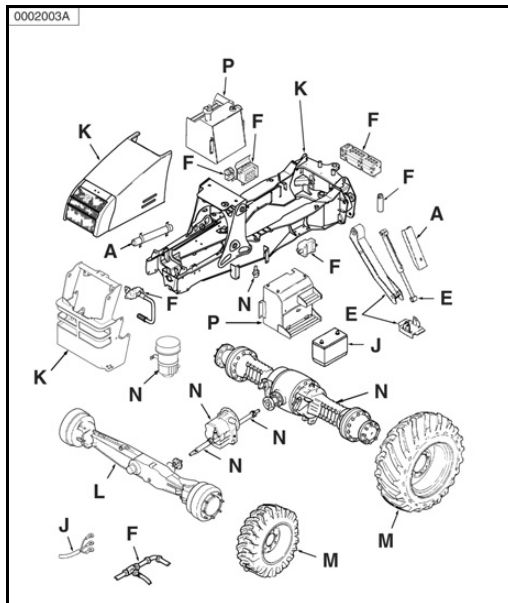
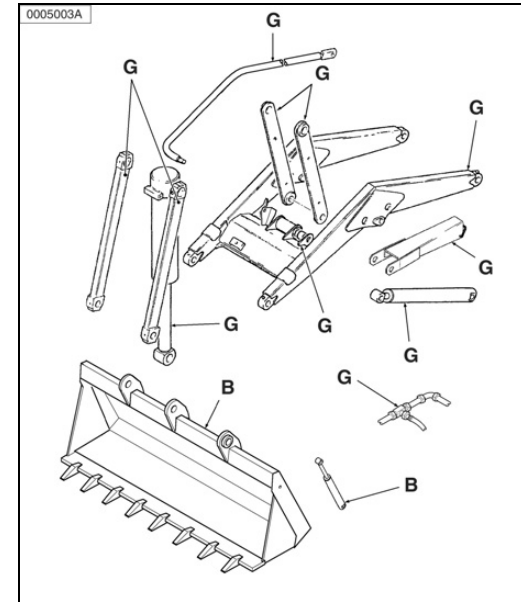
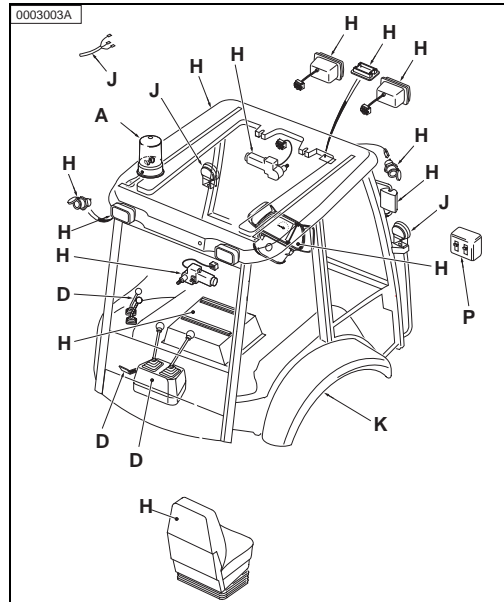
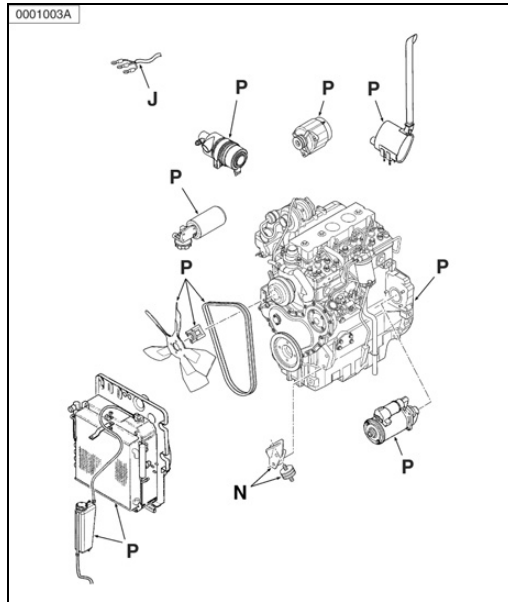

M - Wheels And Tyres • Roues et pneus • Ruedas y neumáticos

Front Wheels	18001C01.1	Roues Avants	Ruedas delanteras
Front Wheels	18004C01.1	Roues Avants	Ruedas delanteras
Front Wheels	18005C01.1	Roues Avants	Ruedas delanteras
Front Wheels	18008C01.1	Roues Avants	Ruedas delanteras
Front Wheels	18014C01.1	Roues Avants	Ruedas delanteras
Front Wheels	18015C01.1	Roues Avants	Ruedas delanteras
Front Wheels	18016C01.1	Roues Avants	Ruedas delanteras
Front Wheels	18017C01.1	Roues Avants	Ruedas delanteras
Rear Wheels	19001C01.1	Roues Arrières	Ruedas traseras
Rear Wheels	19002C01.1	Roues Arrières	Ruedas traseras
Rear Wheels	19003C01.1	Roues Arrières	Ruedas traseras
Rear Wheels	19006C01.1	Roues Arrières	Ruedas traseras
Rear Wheels	19008C01.1	Roues Arrières	Ruedas traseras
Rear Wheels	19009C01.1	Roues Arrières	Ruedas traseras
Rear Wheels	19013C01.1	Roues Arrières	Ruedas traseras
Rear Wheels	19014C01.1	Roues Arrières	Ruedas traseras
Rear Wheels	19015C01.1	Roues Arrières	Ruedas traseras
Rear Wheels	19016C01.1	Roues Arrières	Ruedas traseras
Rear Wheels	19017C01.1	Roues Arrières	Ruedas traseras



Front Wheels
Roues Avants
Ruedas delanteras

C-18001-01.1-A

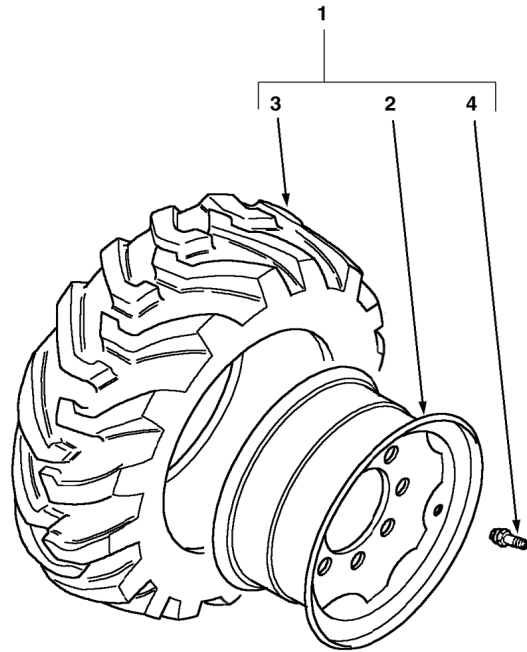

1	6109596M91Y02	(A)	2	Wheel Assy	Ensemble de roue	Rueda, Conj.
2	6109593M91Y02	1 W8L x 16	1	Wheel	Roue	Rueda
3	3511097M1	1 11L x 16 12 PLY F3	1	Tyre	Pneumatique	Neumático
4	842537M1	1	1	Valve Stem	Valve de gonflage	Válvula de inflado
1	6109596M91W01	(A)	2	Wheel Assy	Ensemble de roue	Rueda, Conj.
2	6109593M91W01	1 W8L x 16	1	Wheel	Roue	Rueda
3	3511097M1	1 11L x 16 12 PLY F3	1	Tyre	Pneumatique	Neumático
4	842537M1	1	1	Valve Stem	Valve de gonflage	Válvula de inflado

A Not serviced - order details
 Non fourni - commander détails
 No suministradas - pedir detalles



820
 TX760B TX860B
 TX870B

801 802 805 806 809 810 811 812

18001C01.1

6199042M3

1

Jan-06

Front Wheels
Roues Avants
Ruedas delanteras

C-18004-01.1-A

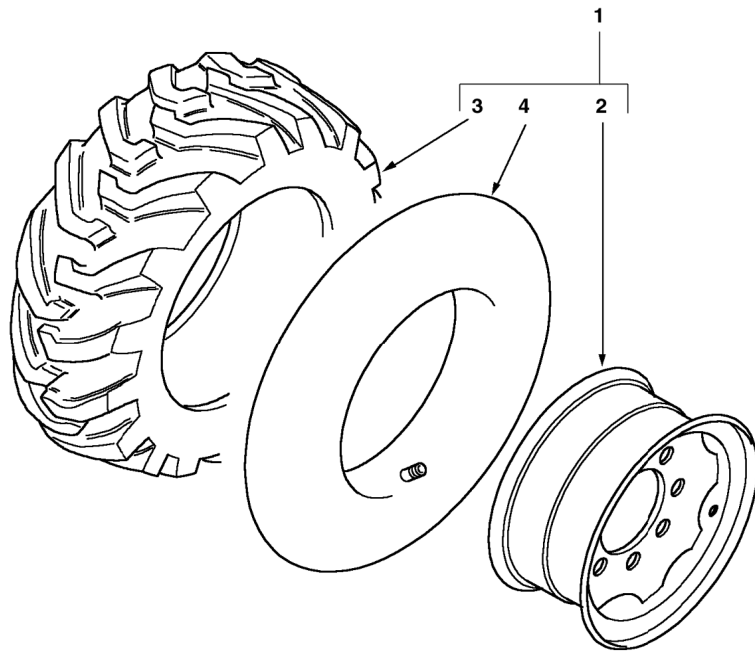

1	6109597M91Y02	(A)	2	Wheel Assy	Ensemble de roue	Rueda, Conj.
2	6109593M91Y02	1 W8L x 16	1	Wheel	Roue	Rueda
3	3511080M1	1 9.00 x 16 10 PLY F2	1	Tyre	Pneumatique	Neumático
4	880481M1	1	1	Tube, Air	Chambre à air	Cámara de aire
1	6109597M91W01	(A)	2	Wheel Assy	Ensemble de roue	Rueda, Conj.
2	6109593M91W01	1 W8L x 16	1	Wheel	Roue	Rueda
3	3511080M1	1 9.00 x 16 10 PLY F2	1	Tyre	Pneumatique	Neumático
4	880481M1	1	1	Tube, Air	Chambre à air	Cámara de aire

A Not serviced - order details
Non fourni - commander détails
No suministradas - pedir detalles



820
TX760B

801 802 805 806

18004C01.1

6199042M3

1

Jan-06

Front Wheels
Roues Avants
Ruedas delanteras

C-18005-01.1-A

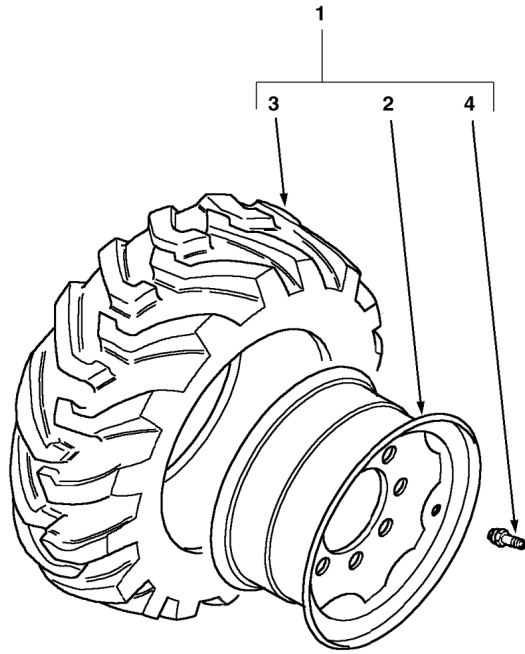

1	6109599M91Y02	(A)	1	Wheel Assy	Ensemble de roue	Rueda, Conj.
1	6109598M91Y02	(A)	1	Wheel Assy	Ensemble de roue	Rueda, Conj.
2	6109594M91Y02	1 9 x 18	1	Wheel	Roue	Rueda
3	1473951M2	1 10.5/80 x 18 10P	1	Tyre	Pneumatique	Neumático
4	842537M1	1	1	Valve Stem	Valve de gonflage	Válvula de inflado
1	6109599M91W01	(A)	1	Wheel Assy	Ensemble de roue	Rueda, Conj.
1	6109598M91W01	(A)	1	Wheel Assy	Ensemble de roue	Rueda, Conj.
2	6109594M91W01	1 9 x 18	1	Wheel	Roue	Rueda
3	1473951M2	1 10.5/80 x 18 10P	1	Tyre	Pneumatique	Neumático
4	842537M1	1	1	Valve Stem	Valve de gonflage	Válvula de inflado

A Not serviced - order details
 Non fourni - commander détails
 No suministradas - pedir detalles



820
 TX760B

801 802 805 806

Front Wheels
Roues Avants
Ruedas delanteras

C-18008-01.1-A

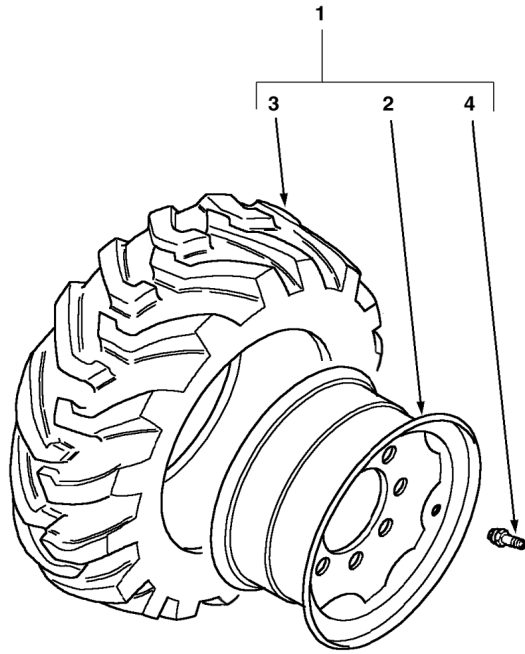

1	6109029M91Y02	(A)	1	Wheel Assy	Ensemble de roue	Rueda, Conj.
1	6109028M91Y02	(A)	1	Wheel Assy	Ensemble de roue	Rueda, Conj.
2	6109030M91Y02	1	11 x 18	Wheel	Roue	Rueda
3	3504261M2	1	12.5 x 18 10P	Tyre	Pneumatique	Neumático
4	842537M1	1		Valve Stem	Valve de gonflage	Válvula de inflado
1	6109029M91W01	(A)	1	Wheel Assy	Ensemble de roue	Rueda, Conj.
1	6109028M91W01	(A)	1	Wheel Assy	Ensemble de roue	Rueda, Conj.
2	6109030M91W01	1	11 x 18	Wheel	Roue	Rueda
3	3504261M2	1	12.5 x 18 10P	Tyre	Pneumatique	Neumático
4	842537M1	1		Valve Stem	Valve de gonflage	Válvula de inflado

A Not serviced - order details
 Non fourni - commander détails
 No suministradas - pedir detalles



820
 TX760B

807 808 833 834

Front Wheels
Roues Avants
Ruedas delanteras

C-18014-01.1-A

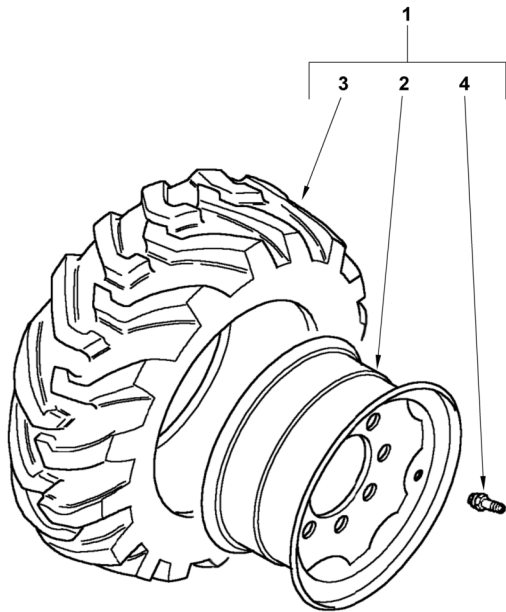

1	6110737M91Y02	(A) ◀ Mitas - 16/70x20 14P TR-09 Ind	1	Wheel Assy	Ensemble de roue	Rueda, Conj.
1	6110738M91Y02	(A) ▶ Mitas - 16/70x20 14P TR-09 Ind	1	Wheel Assy	Ensemble de roue	Rueda, Conj.
2	6109027M91	13 X 20	1	Wheel	Roue	Rueda
3	6110755M1	Mitas 16/70x20 14P TR-09 Ind	1	Tyre	Pneumatique	Neumático
4	842537M1		1	Valve Stem	Valve de gonflage	Válvula de inflado
1	6110737M91W01	(A) ◀ Mitas 16/70x20 14P TR-09 Ind	1	Wheel Assy	Ensemble de roue	Rueda, Conj.
1	6110738M91W01	(A) ▶ Mitas - 16/70x20 14P TR-09 Ind	1	Wheel Assy	Ensemble de roue	Rueda, Conj.
2	6109027M91	13 X 20	1	Wheel	Roue	Rueda
3	6110755M1	Mitas 16/70x20 14P TR-09 Ind	1	Tyre	Pneumatique	Neumático
4	842537M1		1	Valve Stem	Valve de gonflage	Válvula de inflado

A Not serviced - order details
 Non fourni - commander détails
 No suministradas - pedir detalles



860 880
 TX860B TX870B

813 814 815 816 817 821 822 823 824 825 841 842 843 844 845 851 852 853 855

Front Wheels
Roues Avants
Ruedas delanteras

C-18015-01.1-A

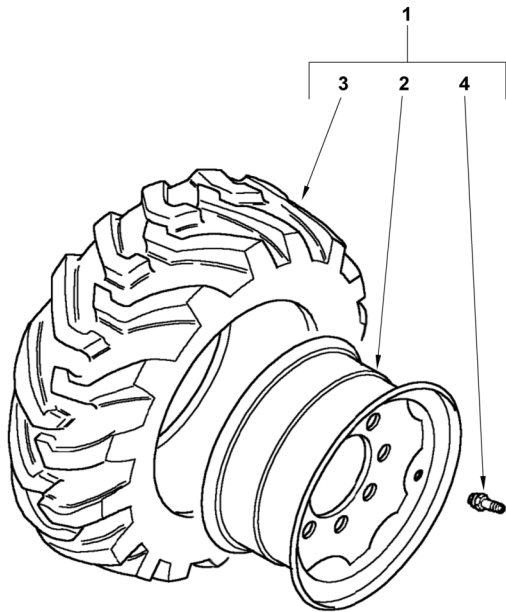

1	6110739M91Y 02	(A) ◀	1	Wheel Assy	Ensemble de roue	Rueda, Conj.
1	6110740M91Y 02	(A) ▶	1	Wheel Assy	Ensemble de roue	Rueda, Conj.
2	6109030M91		1	Wheel	Roue	Rueda
3	6110756M1		1	Tyre	Pneumatique	Neumático
4	842537M1		1	Valve Stem	Valve de gonflage	Válvula de inflado
1	6110739M91 W01	(A) ◀	1	Wheel Assy	Ensemble de roue	Rueda, Conj.
1	6110740M91 W01	(A) ▶	1	Wheel Assy	Ensemble de roue	Rueda, Conj.
2	6109030M91		1	Wheel	Roue	Rueda
3	6110756M1		1	Tyre	Pneumatique	Neumático
4	842537M1		1	Valve Stem	Valve de gonflage	Válvula de inflado

A Not serviced - order details
 Non fourni - commander détails
 No suministradas - pedir detalles



820 860 880
 TX760B TX860B
 TX870B

803 804 813 814 815 816 821 822 823 824 831 832 844 845 851 852 853 854

**Front Wheels
Roues Avants
Ruedas delanteras**

C-18016-01.1-A

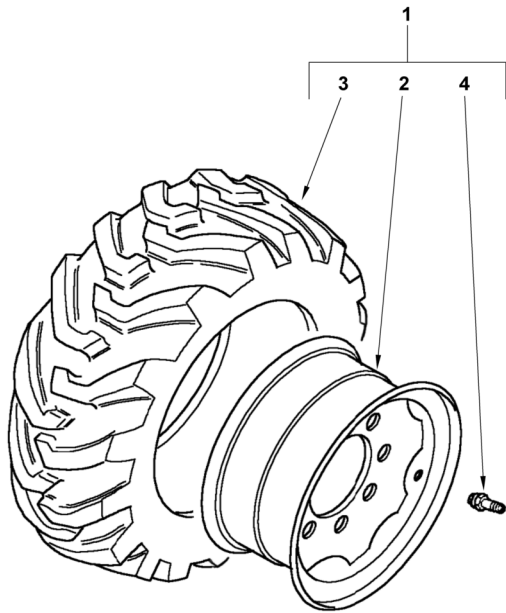

1	6110741M91Y02	(A) ◀ Mitas 405/70x20 14P MPT01 Ag	1	Wheel Assy	Ensemble de roue	Rueda, Conj.
1	6110742M91Y02	(A) ▶ Mitas 405/70x20 14P MPT01 Ag	1	Wheel Assy	Ensemble de roue	Rueda, Conj.
2	6109027M91	13 X 20	1	Wheel	Roue	Rueda
3	6110757M1	Mitas 405/70x20 14P MPT01 Ag	1	Wheel Assy	Ensemble de roue	Rueda, Conj.
4	842537M1		1	Valve Stem	Valve de gonflage	Válvula de inflado
1	6110741M91W01	(A) ◀ Mitas 405/70x20 14P MPT01 Ag	1	Wheel Assy	Ensemble de roue	Rueda, Conj.
1	6110742M91W01	(A) ▶ Mitas 405/70x20 14P MPT01 Ag	1	Wheel Assy	Ensemble de roue	Rueda, Conj.
2	6109027M91	13 X 20	1	Wheel	Roue	Rueda
3	6110757M1	Mitas 405/70x20 14P MPT01 Ag	1	Wheel Assy	Ensemble de roue	Rueda, Conj.
4	842537M1		1	Valve Stem	Valve de gonflage	Válvula de inflado

A Not serviced - order details
Non fourni - commander détails
No suministradas - pedir detalles



860 880
TX860B TX870B

813 814 815 816 817 821 822 823 824 825 841 842 843 844 845 851 852 853 854
855

Front Wheels
Roues Avants
Ruedas delanteras

C-18017-01.1-A

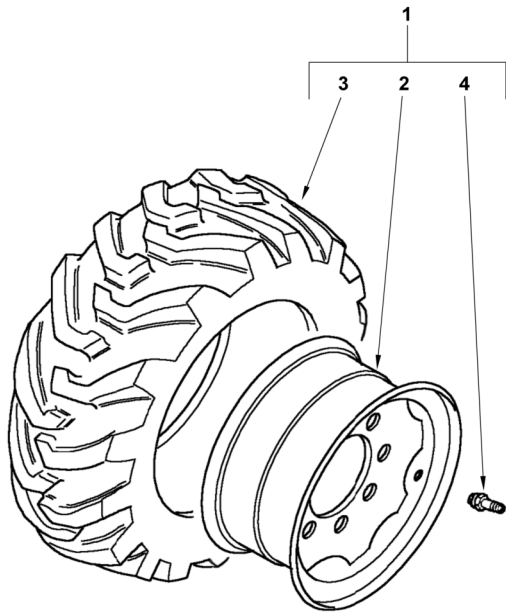

1	6110881M91Y 02	(A) ▲	1	Wheel Assy	Ensemble de roue	Rueda, Conj.
1	6110882M91Y 02	(A) ▶	1	Wheel Assy	Ensemble de roue	Rueda, Conj.
2	6109030M91		1	Wheel	Roue	Rueda
3	6110878M1	12.5/80 x 18 10P	1	Tyre	Pneumatique	Neumático
4	842537M1		1	Valve Stem	Valve de gonflage	Válvula de inflado
1	6110881M91 W01	(A) ▲	1	Wheel Assy	Ensemble de roue	Rueda, Conj.
1	6110882M91 W01	(A) ▶	1	Wheel Assy	Ensemble de roue	Rueda, Conj.
2	6109030M91		1	Wheel	Roue	Rueda
3	6110878M1	12.5/80 x 18 10P	1	Tyre	Pneumatique	Neumático
4	842537M1		1	Valve Stem	Valve de gonflage	Válvula de inflado

A Not serviced - order details
 Non fourni - commander détails
 No suministradas - pedir detalles



820
TX760B

807 808 833 834

18017C01.1

6199042M3

1

Jan-06

Rear Wheels
Roues Arrières
Ruedas traseras

C-19001-01.1-A

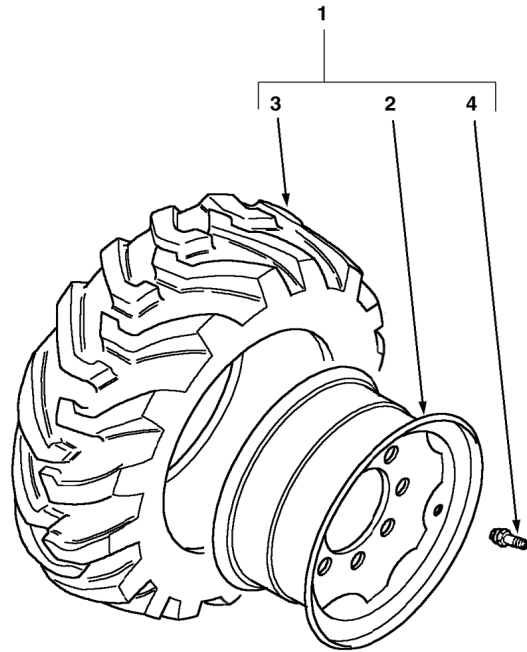

1	6103242M92Y02	(A)	1	Wheel Assy	Ensemble de roue	Rueda, Conj.
1	6103241M92Y02	(A)	1	Wheel Assy	Ensemble de roue	Rueda, Conj.
2	6103189M91	1 W15L	1	Rim, Wheel	Jante	Llanta
3	6109837M1	1 16.9 x 28 12P	1	Tyre	Pneumatique	Neumático
4	842537M1	1	1	Valve Stem	Valve de gonflage	Válvula de inflado
1	6103242M92W01	(A)	1	Wheel Assy	Ensemble de roue	Rueda, Conj.
1	6103241M92W01	(A)	1	Wheel Assy	Ensemble de roue	Rueda, Conj.
2	6103189M91	1 W15L	1	Rim, Wheel	Jante	Llanta
3	6109837M1	1 16.9 x 28 12P	1	Tyre	Pneumatique	Neumático
4	842537M1	1	1	Valve Stem	Valve de gonflage	Válvula de inflado

A Not serviced - order details
 Non fourni - commander détails
 No suministradas - pedir detalles



820
 TX760B

801 802 805 806

Rear Wheels
Roues Arrières
Ruedas traseras

C-19002-01.1-A

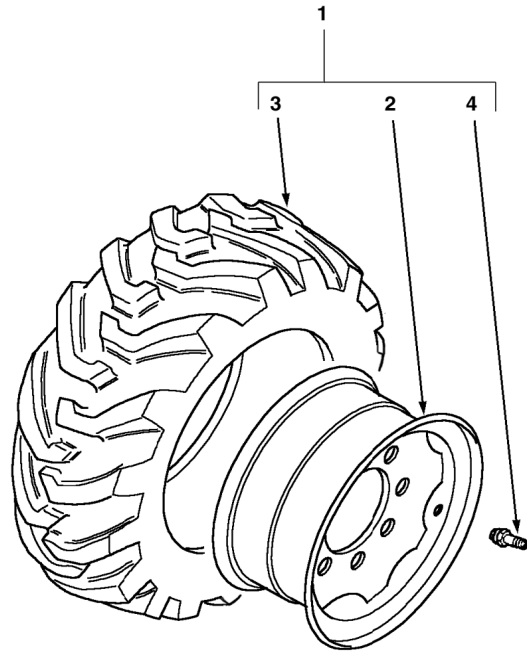

1	6103250M92Y02	(A)	1	Wheel Assy	Ensemble de roue	Rueda, Conj.
1	6103249M92Y02	(A)	1	Wheel Assy	Ensemble de roue	Rueda, Conj.
2	6103191M91	1 DW15L	1	Rim, Wheel	Jante	Llanta
3	6109839M1	1 16.9 x 30 10P	1	Tyre	Pneumatique	Neumático
4	842537M1	1	1	Valve Stem	Valve de gonflage	Válvula de inflado
1	6103250M92W01	(A)	1	Wheel Assy	Ensemble de roue	Rueda, Conj.
1	6103249M92W01	(A)	1	Wheel Assy	Ensemble de roue	Rueda, Conj.
2	6103191M91	1 DW15L	1	Rim, Wheel	Jante	Llanta
3	6109839M1	1 16.9 x 30 10P	1	Tyre	Pneumatique	Neumático
4	842537M1	1	1	Valve Stem	Valve de gonflage	Válvula de inflado

A Not serviced - order details
 Non fourni - commander détails
 No suministradas - pedir detalles



820
TX760B

801 802 805 806

Rear Wheels
Roues Arrières
Ruedas traseras

C-19003-01.1-A

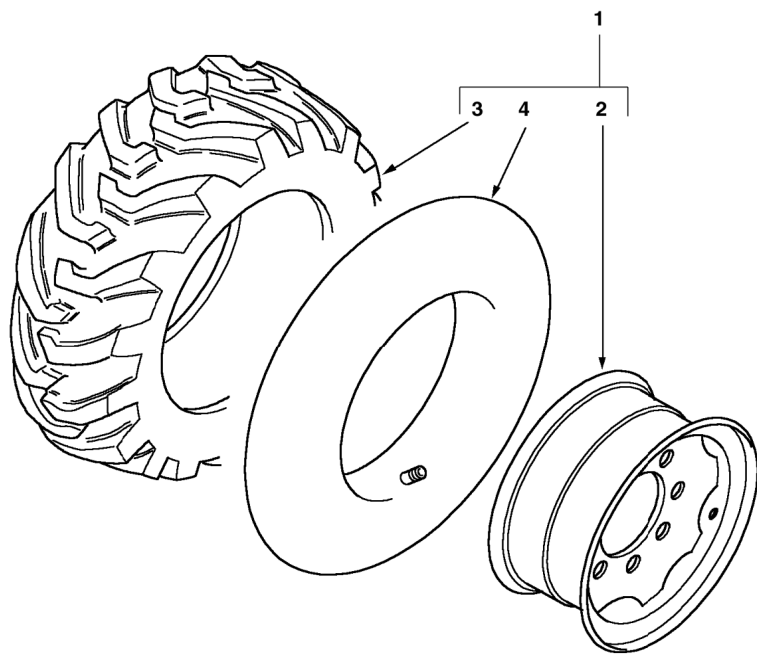

1	6103245M92 W01	(A) ▲	1	Wheel Assy	Ensemble de roue	Rueda, Conj.
1	6103246M92 W01	(A) ▶	1	Wheel Assy	Ensemble de roue	Rueda, Conj.
2	6103187M91	DW16L	1	Rim, Wheel	Jante	Llanta
3	6109736M1	18.4 x 26 R1	1	Tyre	Pneumatique	Neumático
4	1474020M1		1	Tube, Air	Chambre à air	Cámara de aire
1	6103245M92Y 02	(A) ▲	1	Wheel Assy	Ensemble de roue	Rueda, Conj.
1	6103246M92Y 02	(A) ▶	1	Wheel Assy	Ensemble de roue	Rueda, Conj.
2	6103187M91Y 02	DW16L X 26	1	Wheel	Roue	Rueda
3	6109736M1	18.4 x 26 R1	1	Tyre	Pneumatique	Neumático
4	1474020M1		1	Tube, Air	Chambre à air	Cámara de aire

A Not serviced - order details
 Non fourni - commander détails
 No suministradas - pedir detalles



820
TX760B

801 802 805 806

**Rear Wheels
Roues Arrières
Ruedas traseras**

C-19006-01.1-A

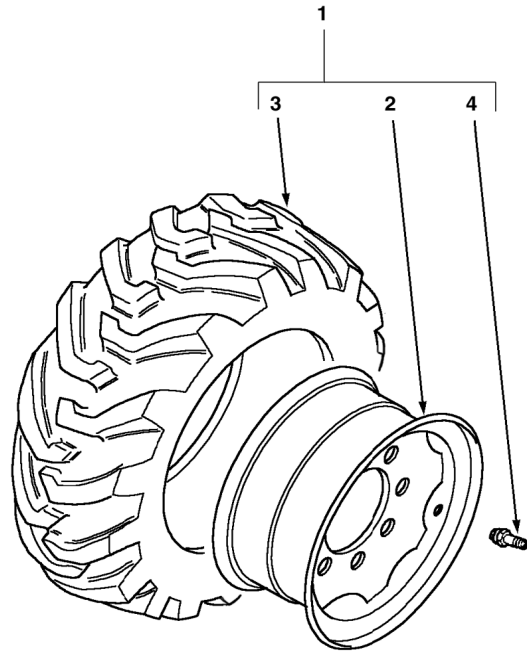

1	6109464M91Y02	(A)	1	Wheel Assy	Ensemble de roue	Rueda, Conj.
1	6109463M91Y02	(A)	1	Wheel Assy	Ensemble de roue	Rueda, Conj.
2	6103185M91	1 W15L	1	Rim, Wheel	Jante	Llanta
3	6109465M1	1 19.5L x 24 12PLY R4	1	Tyre	Pneumatique	Neumático
4	842537M1	1	1	Valve Stem	Valve de gonflage	Válvula de inflado
1	6109464M91W01	(A)	1	Wheel Assy	Ensemble de roue	Rueda, Conj.
1	6109463M91W01	(A)	1	Wheel Assy	Ensemble de roue	Rueda, Conj.
2	6103185M91	1 W15L	1	Rim, Wheel	Jante	Llanta
3	6109465M1	1 19.5L x 24 12PLY R4	1	Tyre	Pneumatique	Neumático
4	842537M1	1	1	Valve Stem	Valve de gonflage	Válvula de inflado

A Not serviced - order details
Non fourni - commander détails
No suministradas - pedir detalles



820
TX760B TX860B
TX870B

801 802 809 810 811 812

Rear Wheels
Roues Arrières
Ruedas traseras

C-19008-01.1-A

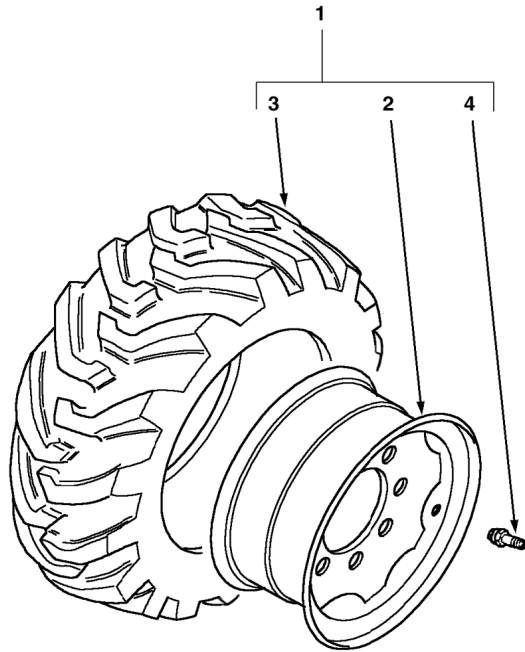

1	6108065M91Y02	(A)	2	Wheel Assy	Ensemble de roue	Rueda, Conj.
1	6108064M91Y02	(A)	2	Wheel Assy	Ensemble de roue	Rueda, Conj.
2	6103183M91Y02	1 W15L	1	Rim, Wheel	Jante	Llanta
3	6106242M1	1 16.9 R24	1	Tyre	Pneumatique	Neumático
4	842537M1	1	1	Valve Stem	Valve de gonflage	Válvula de inflado
1	6108065M91W01	(A)	2	Wheel Assy	Ensemble de roue	Rueda, Conj.
1	6108064M91W01	(A)	2	Wheel Assy	Ensemble de roue	Rueda, Conj.
2	6103183M91W01	1 W15L	1	Rim, Wheel	Jante	Llanta
3	6106242M1	1 16.9 R24	1	Tyre	Pneumatique	Neumático
4	842537M1	1	1	Valve Stem	Valve de gonflage	Válvula de inflado

A Not serviced - order details
 Non fourni - commander détails
 No suministradas - pedir detalles



970 980
 TX970B

921 922 923 931 932

Rear Wheels
Roues Arrières
Ruedas traseras

C-19009-01.1-A

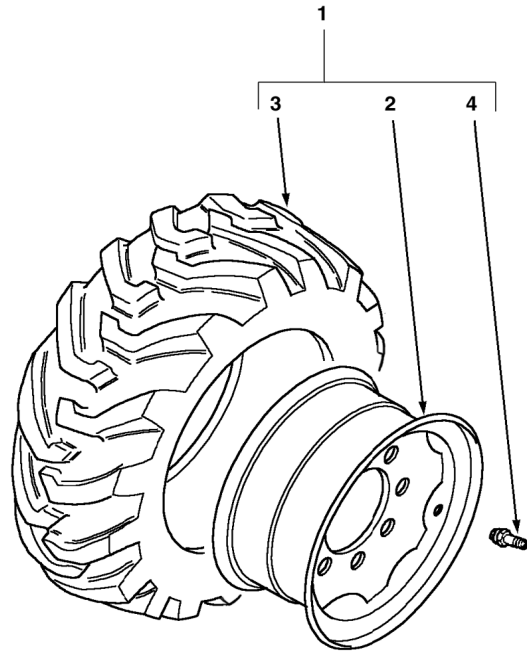

1	6108067M91Y02	(A)	2	Wheel Assy	Ensemble de roue	Rueda, Conj.
1	6108066M91Y02	(A)	2	Wheel Assy	Ensemble de roue	Rueda, Conj.
2	6103183M91Y02	1	W15L	Rim, Wheel	Jante	Llanta
3	6100225M1	1	17.5 LR24 x M27 TL146	Tyre	Pneumatique	Neumático
4	842537M1	1		Valve Stem	Valve de gonflage	Válvula de inflado
1	6108067M91W01	(A)	2	Wheel Assy	Ensemble de roue	Rueda, Conj.
1	6108066M91W01	(A)	2	Wheel Assy	Ensemble de roue	Rueda, Conj.
2	6103183M91W01	1	W15L	Rim, Wheel	Jante	Llanta
3	6100225M1	1	17.5 LR24 x M27 TL146	Tyre	Pneumatique	Neumático
4	842537M1	1		Valve Stem	Valve de gonflage	Válvula de inflado

A Not serviced - order details
 Non fourni - commander détails
 No suministradas - pedir detalles



970 980
 TX970B

921 922 923 931 932

**Rear Wheels
Roues Arrières
Ruedas traseras**

C-19013-01.1-A

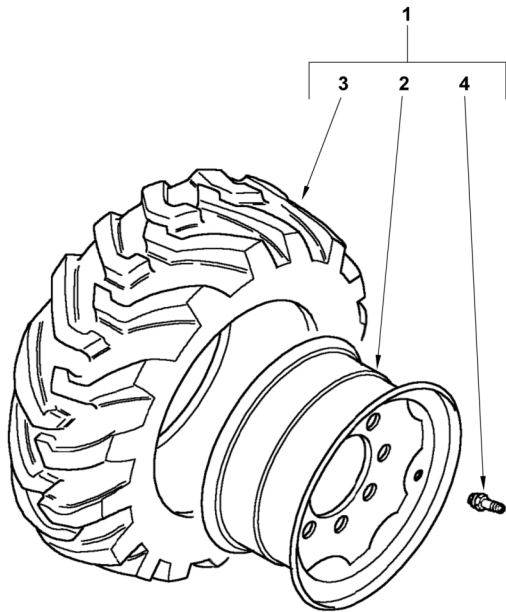

1	6110743M91Y 02	(A) ▲	1	Wheel Assy	Ensemble de roue	Rueda, Conj.
1	6110744M91Y 02	(A) ▶	1	Wheel Assy	Ensemble de roue	Rueda, Conj.
2	6109030M91		1	Wheel	Roue	Rueda
3	6110758M1	11 x 18	1	Tyre	Pneumatique	Neumático
4	842537M1		1	Valve Stem	Valve de gonflage	Válvula de inflado
1	6110743M91 W01	(A) ▲	1	Wheel Assy	Ensemble de roue	Rueda, Conj.
1	6110744M91 W01	(A) ▶	1	Wheel Assy	Ensemble de roue	Rueda, Conj.
2	6109030M91		1	Wheel	Roue	Rueda
3	6110758M1	11 x 18	1	Tyre	Pneumatique	Neumático
4	842537M1		1	Valve Stem	Valve de gonflage	Válvula de inflado

A Not serviced - order details
Non fourni - commander détails
No suministradas - pedir detalles



820
TX760B

807 808 833 834

Rear Wheels
Roues Arrières
Ruedas traseras

C-19014-01.1-A

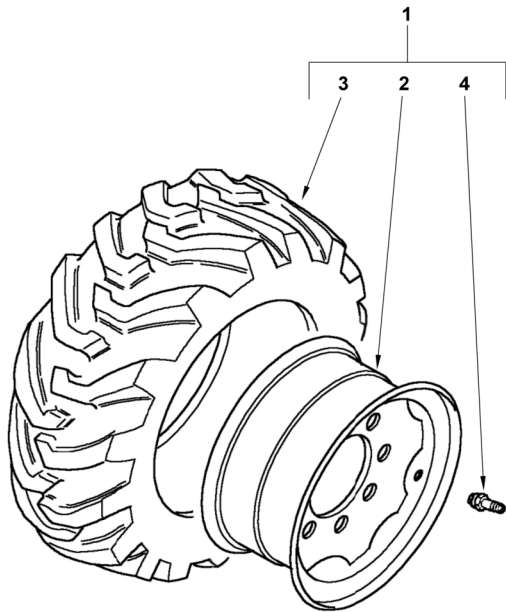

1	6110745M91Y02	(A) ◀ Mitas 16.9x24 12P I-04 Ind	1	Wheel Assy	Ensemble de roue	Rueda, Conj.
1	6110746M91Y02	(A) ▶ Mitas 19.9x24 12P TI-04 Ind	1	Wheel Assy	Ensemble de roue	Rueda, Conj.
2	6103183M91Y02	W15L	1	Rim, Wheel	Jante	Llanta
3	6110759M1	Mitas 16.9x24 12P TI-04 Ind	1	Tyre	Pneumatique	Neumático
4	842537M1		1	Valve Stem	Valve de gonflage	Válvula de inflado
1	6110745M91W01	(A) ◀ Mitas 16.9x24 12P TI-04 Ind	1	Wheel Assy	Ensemble de roue	Rueda, Conj.
1	6110746M91W01	(A) ▶ Mitas 16.9x24 123P TI-04 Ind	1	Wheel Assy	Ensemble de roue	Rueda, Conj.
2	6103183M91W01	W15L	1	Rim, Wheel	Jante	Llanta
3	6110759M1	Mitas 16.9x24 12P TI-04 Ind	1	Tyre	Pneumatique	Neumático
4	842537M1		1	Valve Stem	Valve de gonflage	Válvula de inflado

A Not serviced - order details
 Non fourni - commander détails
 No suministradas - pedir detalles



970 980
 TX970B

921 922 923 931 932

Rear Wheels
Roues Arrières
Ruedas traseras

C-19015-01.1-A

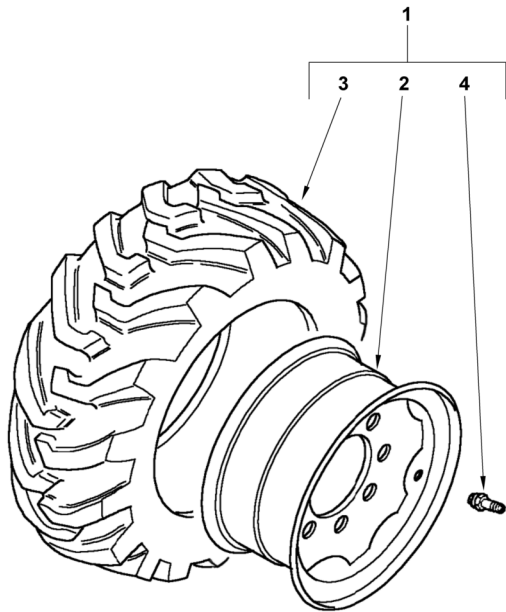

1	6110747M91Y 02	(A) ▲	1	Wheel Assy	Ensemble de roue	Rueda, Conj.
1	6110748M91Y 02	(A) ▶	1	Wheel Assy	Ensemble de roue	Rueda, Conj.
2	6103187M91	DW16L	1	Rim, Wheel	Jante	Llanta
3	6110760M1	18.4 x 26 12P	1	Tyre	Pneumatique	Neumático
4	842537M1		1	Valve Stem	Valve de gonflage	Válvula de inflado
1	6110747M91 W01	(A) ▲	1	Wheel Assy	Ensemble de roue	Rueda, Conj.
1	6110748M91 W01	(A) ▶	1	Wheel Assy	Ensemble de roue	Rueda, Conj.
2	6103187M91	DW16L	1	Rim, Wheel	Jante	Llanta
3	6110760M1	18.4 x 26 12P	1	Tyre	Pneumatique	Neumático
4	842537M1		1	Valve Stem	Valve de gonflage	Válvula de inflado

A Not serviced - order details
 Non fourni - commander détails
 No suministradas - pedir detalles



820 860 880
 TX760B TX860B
 TX870B

807 808 813 814 815 816 817 821 822 823 824 825 833 834 841 842 843 844 845
 851 852 853 854 855

Rear Wheels
Roues Arrières
Ruedas traseras

Not Illustrated

Non Illustrée

Nicht Abgebildet

Non Illustrato

No Ilustrado

1	6110749M91Y 02	(A) ◀	1	Wheel Assy	Ensemble de roue	Rueda, Conj.
1	6110750M91Y 02	(A) ▶	1	Wheel Assy	Ensemble de roue	Rueda, Conj.
2	6103191M91	DW15L	1	Rim, Wheel	Jante	Llanta
3	6110761M1	16.9 x 30 14P	1	Tyre	Pneumatique	Neumático
4	842537M1		1	Valve Stem	Valve de gonflage	Válvula de inflado
1	6110749M91 W01	(A) ◀	1	Wheel Assy	Ensemble de roue	Rueda, Conj.
1	6110750M91 W01	(A) ▶	1	Wheel Assy	Ensemble de roue	Rueda, Conj.
2	6103191M91	DW15L	1	Rim, Wheel	Jante	Llanta
3	6110761M1	16.9 x 30 14P	1	Tyre	Pneumatique	Neumático
4	842537M1		1	Valve Stem	Valve de gonflage	Válvula de inflado

A Not serviced - order details
Non fourni - commander détails
No suministradas - pedir detalles



820 860 880
TX760B TX860B
TX870B

807 808 813 814 815 816 817 821 822 823 824 825 833 834 841 842 843 844 845
851 852 853 855

Rear Wheels
Roues Arrières
Ruedas traseras

C-19017-01.1-A

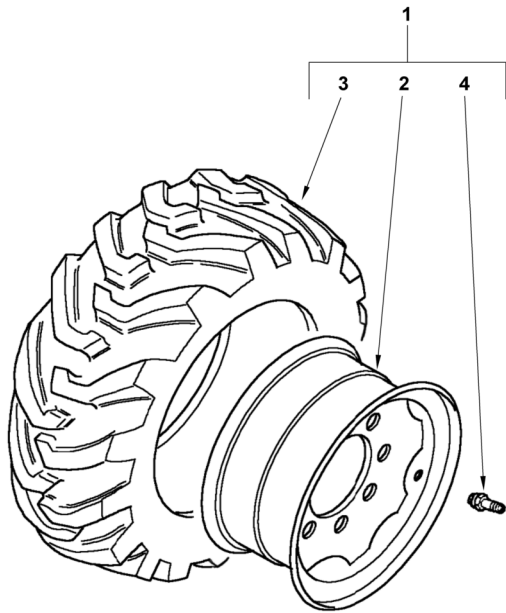

1	6110751M91 W01	(A) ▲	1	Wheel Assy	Ensemble de roue	Rueda, Conj.
1	6110752M91 W01	(A) ▼	1	Wheel Assy	Ensemble de roue	Rueda, Conj.
2	6103185M91Y 02	W15L X 24	1	Wheel	Roue	Rueda
3	6110762M1		1	Tyre	Pneumatique	Neumático
4	842537M1		1	Valve Stem	Valve de gonflage	Válvula de inflado
1	6110751M91Y 02	(A) ▲	1	Wheel Assy	Ensemble de roue	Rueda, Conj.
1	6110752M91Y 02	(A) ▼	1	Wheel Assy	Ensemble de roue	Rueda, Conj.
2	6110762M1		1	Tyre	Pneumatique	Neumático
3	6103185M91Y 02	W15L X 24	1	Wheel	Roue	Rueda
4	842537M1		1	Valve Stem	Valve de gonflage	Válvula de inflado

A Not serviced - order details
 Non fourni - commander détails
 No suministradas - pedir detalles



820 860 880
 TX760B TX860B
 TX870B

803 804 813 814 815 816 821 822 823 824 831 832 844 845 851 852 853 854