



MINIMATIC

REAR – END PACKER TRUCK

SPARE PARTS MANUAL

FARID ORDER : 10A132.001

PUNCHING FARID : 0041/00707

TYPE OF EQUIPMENT : MINIMATIC 8 KIT

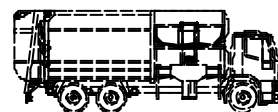
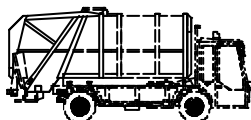
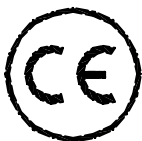

COMPANY
WITH QUALITY SYSTEM
CERTIFIED BY DNV
ISO 9001

Farid Industrie spa
ITALY

INDICE
INDEX

<u>DENOMINAZIONE / NAME</u>	<u>FILE</u>	<u>TAV. / TAB</u>
VOLTACONTENITORI BIN LIFT	MM-CA01-REV-00	T1
	MM-CA01-REV-02	T1A
	MM-CA01-REV-00-evo4	T1B
	MM-CA11-REV-00-evo4	T1CH
	MM-CA01-REV-01	T1D
PALA COMPATTAZIONE PACKER PLATE	MM-CA02-REV-02	T2
	MM-CA02-REV-01	T2A
PARATIA ESPULSIONE EJECTION PLATE	MM-CA03-REV-01	T3
SPONDINA POSTERIORE REAR FLAP	MM-CA04-REV-02	T4
SERBATOIO OLIO E ACCESSORI OIL TANK AND ACCESSORIES	MM-CA05-REV-02	T5
BARRA APRICOPERCHIO COVER BIN BAR	MM-CA06-REV-01	T11
<u>COVER BIN BAR DEVICE</u>		
ACCESSORI ACCESSORIES	MM-CA07-REV-00 MM-CA07-REV-02	T20 -T20A T20B
CILINDRO PARATIA ESPULSIONE CYLINDER FOR EJECTION PLATE	MM-ID01-REV-03	T6
CILINDRI PALA CILYNDERS FOR PACKER PLATE	MM-ID02-REV-01	T7
CILINDRI VOLTACONTENITORI CILYNDERS FOR BIN LIFT	MM-ID03-REV-02	T8
CILINDRO PETTINE CILINDER FOR MOVING FRAME	MM-ID04-REV-01	T9
DISTRIBUTORE IDRAULICO OIL DISTRIBUTOR	MM-ID05-REV-05	T10

INDICE
INDEX

<u>DENOMINAZIONE / NAME</u>	<u>FILE</u>	<u>TAV. / TAB</u>
IN CABINA IN TO CABIN	MM-EL01-REV-01	T12
SENSORI PALA PACKER PLATE - SENSORS	MM-EL02-REV-02	T13
SENSORI VOLTACONTENITORI BIN LIFT - SENSORS	MM-EL03-REV-02	T14
SENSORE SPONDINA REAR FLAP - SENSOR	MM-EL04-REV-03	T15
PULSANTIERA POSTERIORE DESTRA CONTROL BOX SIDE RIGHT (REAR)	MM-EL05-REV-01	T16
PULSANTIERA ANTERIORE DESTRA CONTROL BOX SIDE RIGHT (FRONT)	MM-EL06-REV-00	T17
PULSANTIERA POSTERIORE SINISTRA CONTROL BOX SIDE LEFT (REAR)	MM-EL07-REV-00	T18
SCATOLA ELETTRICA ELECTRIC BOX	MM-EL08-REV-01	T19
ACCESSORI ELETTRICI ELECTRIC ACCESSORIES	MM-EL09-REV-03	T21
ACCESSORI ELETTRICI ELECTRIC ACCESSORIES	MM-EL09-REV-00	T21A
FINECORSA PARATIA ESPULSIONE MICRO SWITCH EJECTION PLATE	MM-EL11-REV-00	T26

 SCHEMA IMPIANTO IDRAULICO DRAWING FARID N° 02110001392-00
 HYDRAULIC DIAGRAM

 SCHEMA IMPIANTO ELETTRICO (DWG. FARID - MM STANDARD - DATED 04-2003)
 ELECTRIC SCHEME

SCHEMA CABINA 24 VOLT EL.-PNEUMATIC (SEE PAGE 35)
 CABIN SCHEME



*** ATTENTION ***

- 1) TO ORDER SPARE PARTS INDICATE:
 - A) EQUIPMENT PUNCHING N° OR VEHICLE CHASSIS N°
 - B) TABLE - N° (IN THE SPARE PARTS CATALOGUE) , CODE AND DESCRIPTION OF THE REQUESTED COMPONENT
 - C) QUANTITY REQUESTED

- 2) REFER TO OUR CUSTOMER SERVICE FOR ANY DOUBT OR EXPLANATION

- 3) DURING THE WARRANTY PERIOD FAULTY COMPONENTS WILL BE REPLACED ONLY AGAINST RETURN OF THOSE DAMAGED.

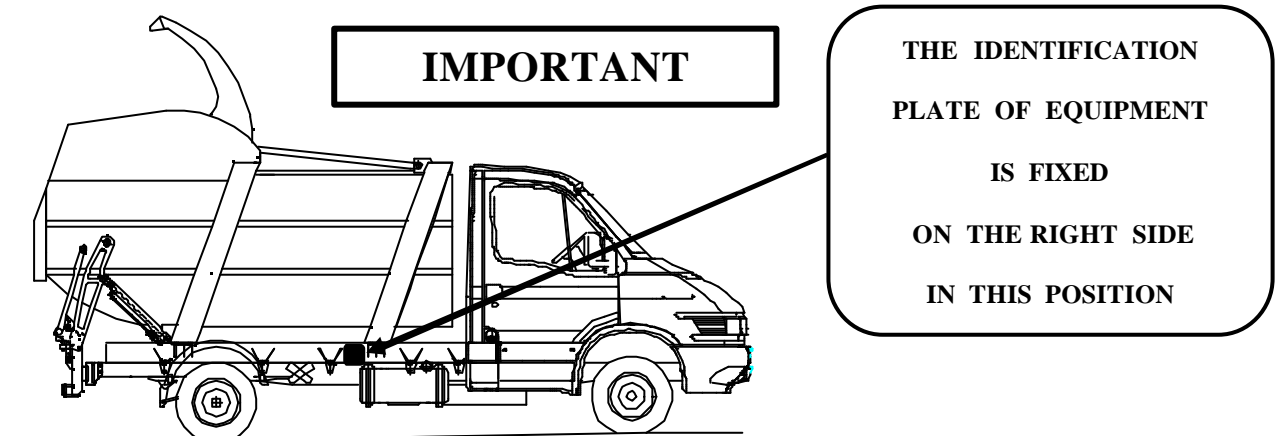

PLEASE SEND THE SPARE PARTS ORDER TO:

FARID INDUSTRIE S.p.a. - Strada Moncalieri 109 - Frazione Tetti Caglieri 10048 VINOVO (TO)
Tel. 011 -9737406 - Fax 011-9737409

OR

FARID – MUNICIPAL VEHICLES LTD.

Rudford Industrial Estate
Ford Arundel – West Sussex
UNITED KINGDOM – BN 18 ODB
E-mail : fariduk@demon.co.ukt

PHONE + 44-1903-732604

FAX

+ 44-1903-732605

CARPENTERIA

CARPENTRY

VOLTACONTENITORI
BIN LIFT

VISTA GENERALE
GENERAL VIEW



VISTA (SPACCATO)
VIEW SPLIT

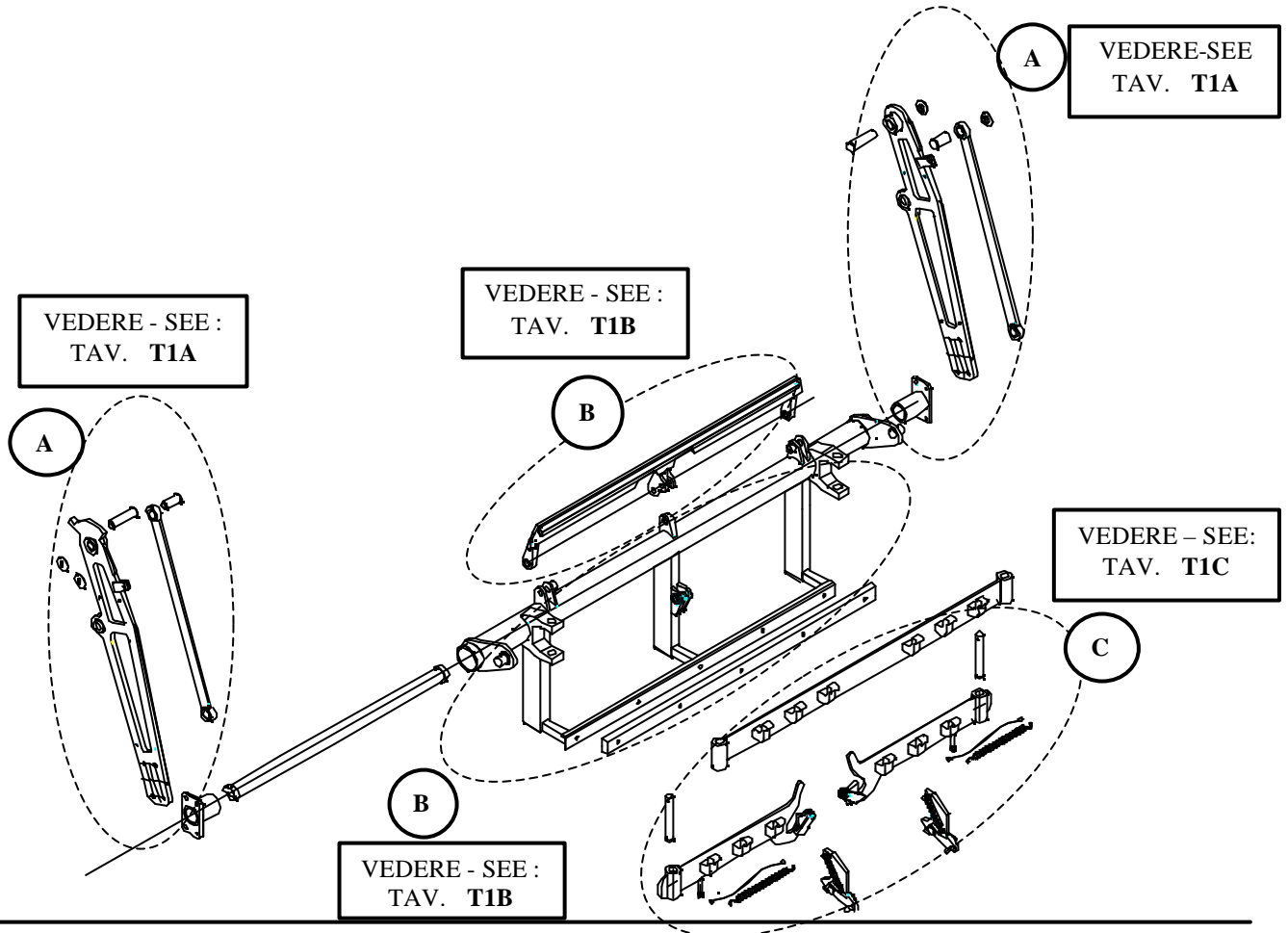

TAV.T1

A - BRACCI PANTOGRAFATI E BIELLINI PANTOGRAPH ARMS AND CONNECTING ROD

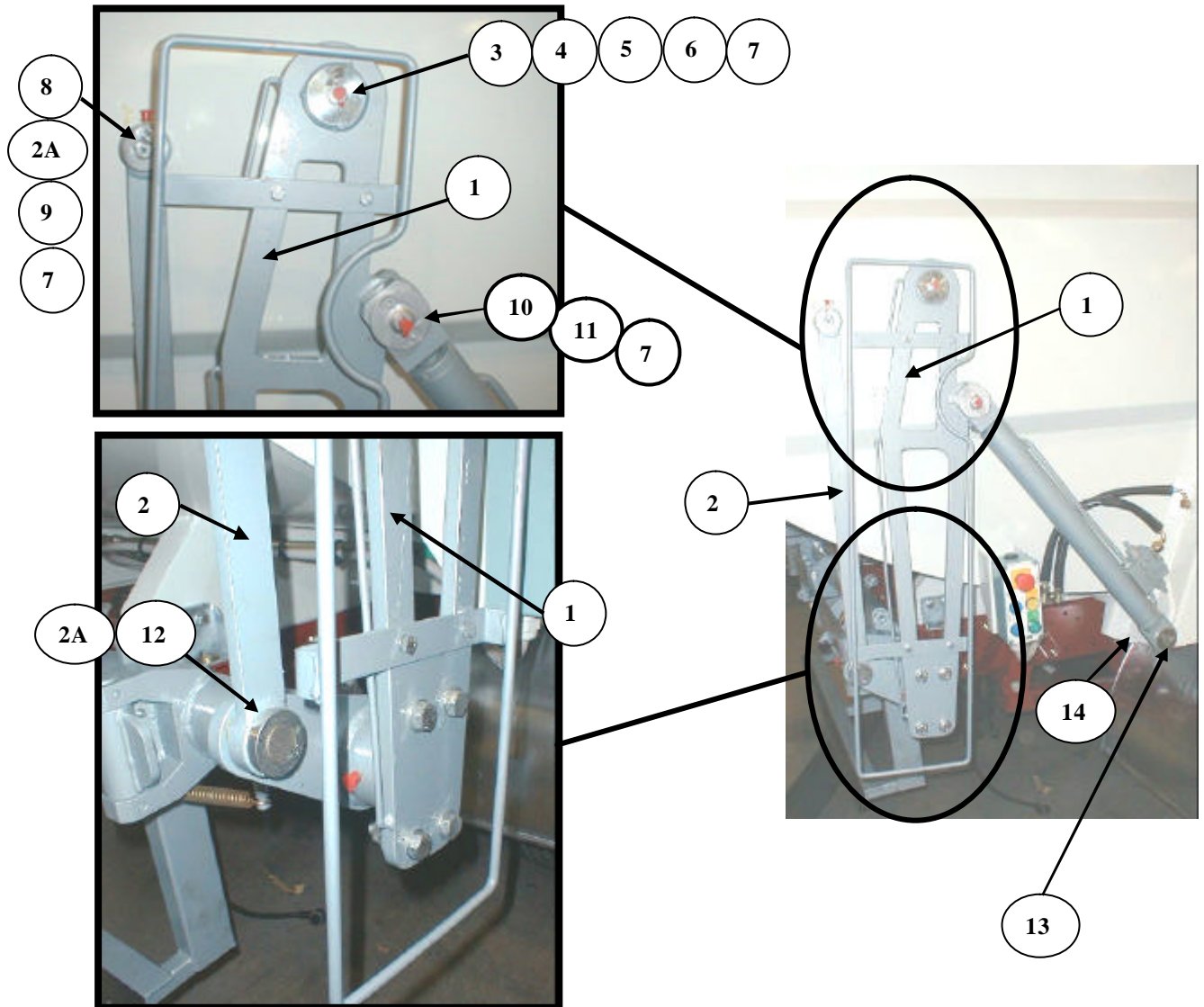

TAV	POS	CODICE	DESCRIZIONE	DESCRIPTION	Q.TY	NOTE
T1A	1	03220003081 03220003082	BRACCIO DESTRO BRACCIO SINISTRO	ARM-RIGHT ARM - LEFT	1 1	L = 930 mm
T1A	2	03220003126	BIELLINO	CONNECTING ROD	2	
T1A	2A	08170001274	BOCCOLA	BUSH	4	
T1A	3	03220003127	PERNO SALDATO	PIN WELDED	2	COMPLETO DI RONDELLA COMPLETE WITH WASHER
T1A	4	08060001286	RONDELLA	WASHER	2	
T1A	5	08170001275	BOCCOLA	BUSH	2+2	
T1A	6	08020001955	VITE	SCREW	2	
T1A	7	08240001006	INGRASSATORE	GREASE NIPPLE	2	M6 x 1
T1A	8	03220003128	PERNO SALDATO	PIN WELDED	2	COMPLETO DI RONDELLA COMPLETE WITH WASHER
T1A	9	08060001287	RONDELLA	WASHER	2	
T1A	10	08010001357	PERNO	PIN	2	
T1A	11	08170001274	BOCCOLA	BUSH	2	
T1A	12	08060001008	ANELLO	DONUT	2	
T1A	13	08060001208 08070001031	RONDELLA ANELLO SEEGER	WASHER DONUT SEEGER	2 2	PER FISSAGGIO CILINDRO FOR FIXING CYLINDER
T1A	14	08010001393	PERNO SALDATO	PIN WELDED	2	

TAV.T1A

FARID Industrie S.p.A

B - BRACCI E PETTINE PER VOLTACONTENITORI Lt 1100 DIN
ARM AND MOVING FRAME FOR BIN LIFT Lt 1100 DIN

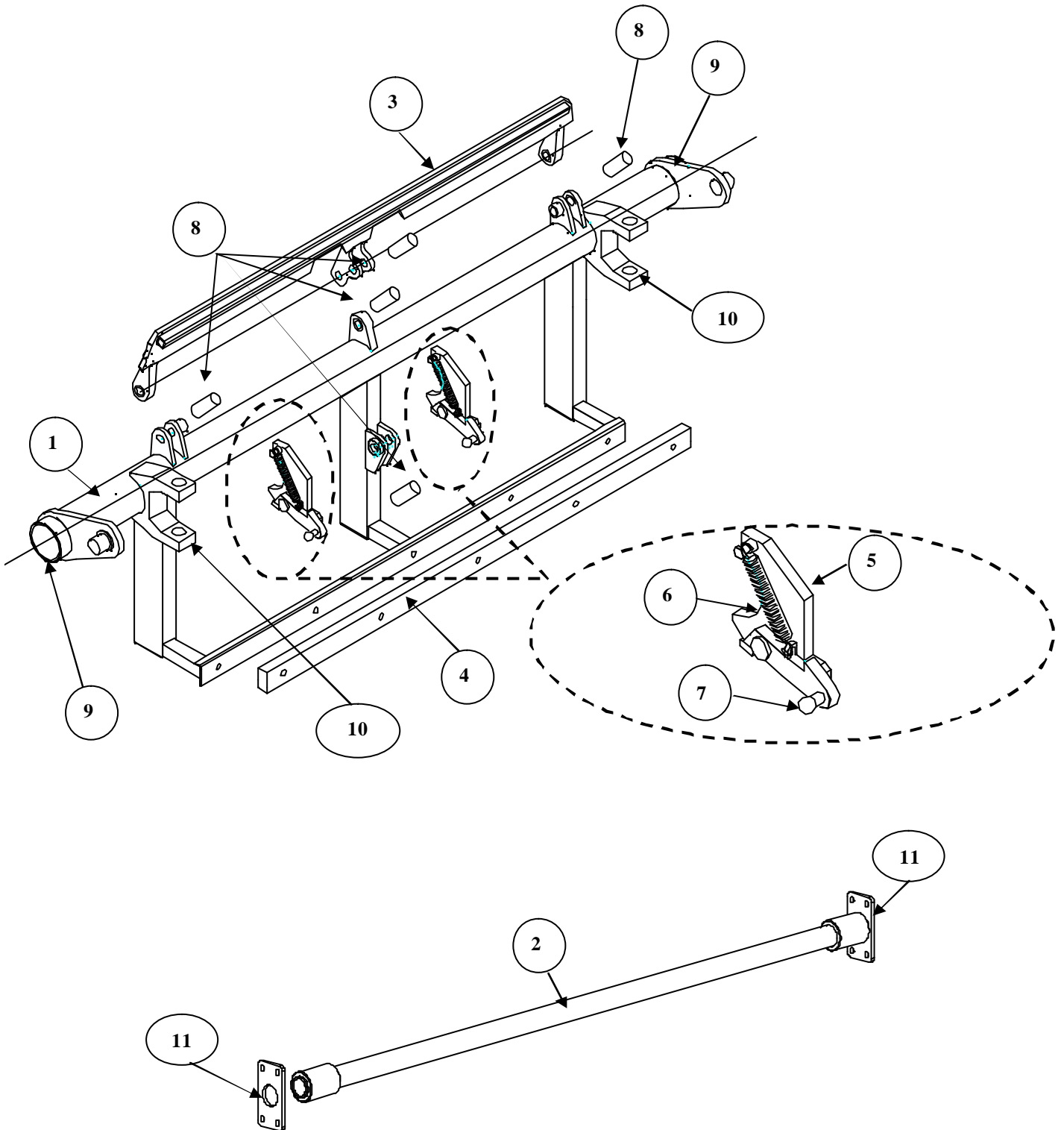

B - BRACCI E PETTINE PER VOLTACONTENITORI Lt 1100 DIN
ARM AND MOVING FRAME FOR BIN LIFT Lt 1100 DIN

TAV	POS	CODICE	DESCRIZIONE	DESCRIPTION	Q.TY	NOTE
T1B	1	03220003087	BARRA ESTERNA	EST. - BAR	1	
T1B	2	03220005171	BARRA INTERNA	INT. - BAR	1	COMPLETA-COMLETE
T1B	3	03220006035	RISCONTRO PETTINE	SUPPORT- MOVING-FRAME	1	
T1B	4	03220003088	RISCONTRO NYLON	SUPPORT-NYLON	1	
T1B	5	03220006077	CHIAVISTELLO	DOOR LATCH	1	DESTRO-RIGHT
		03220006080	BRACCI COMPLETO	COMPLETE	1	SINISTRO-LEFT
T1B	6	08300001029	MOLLA	SPRING	2	
T1B	7	08290001052	POMELLO A SFERA	KNOB-SPHERE	2	
T1B	8	03220003130	PERNO	PIN	5	
T1B	9	08170001276	BOCCOLA	BUSH	2	
T1B	10	03220005273	MAGNONE BRACCI	SUPPORT ARMS	2	
T1B	11	03220003387	FLANGIA-BARRONE	FLANGE	2	

NOTA PER POSIZIONE 2
NOTE FOR POSITION 2

LA BARRA INTERNA (2) COMPLETA VERRA' FORNITA CON UNA
 FLANGIA (11) NON SALDATA SU UN LATO

THE INTERNAL BAR (2) COMPLETE WILL BE' FURNISHED WITH
 ONE FLANGE (11) NOT WELDED

PAGINA
SHEET

2/2

TAV.T1B

FARID Industrie S.p.A

C - BRACCI PER VOLTACONTENITORI Lt 1100 DIN - EVO4

ARMS FOR BIN LIFT Lt. 1100 DIN - EVO4

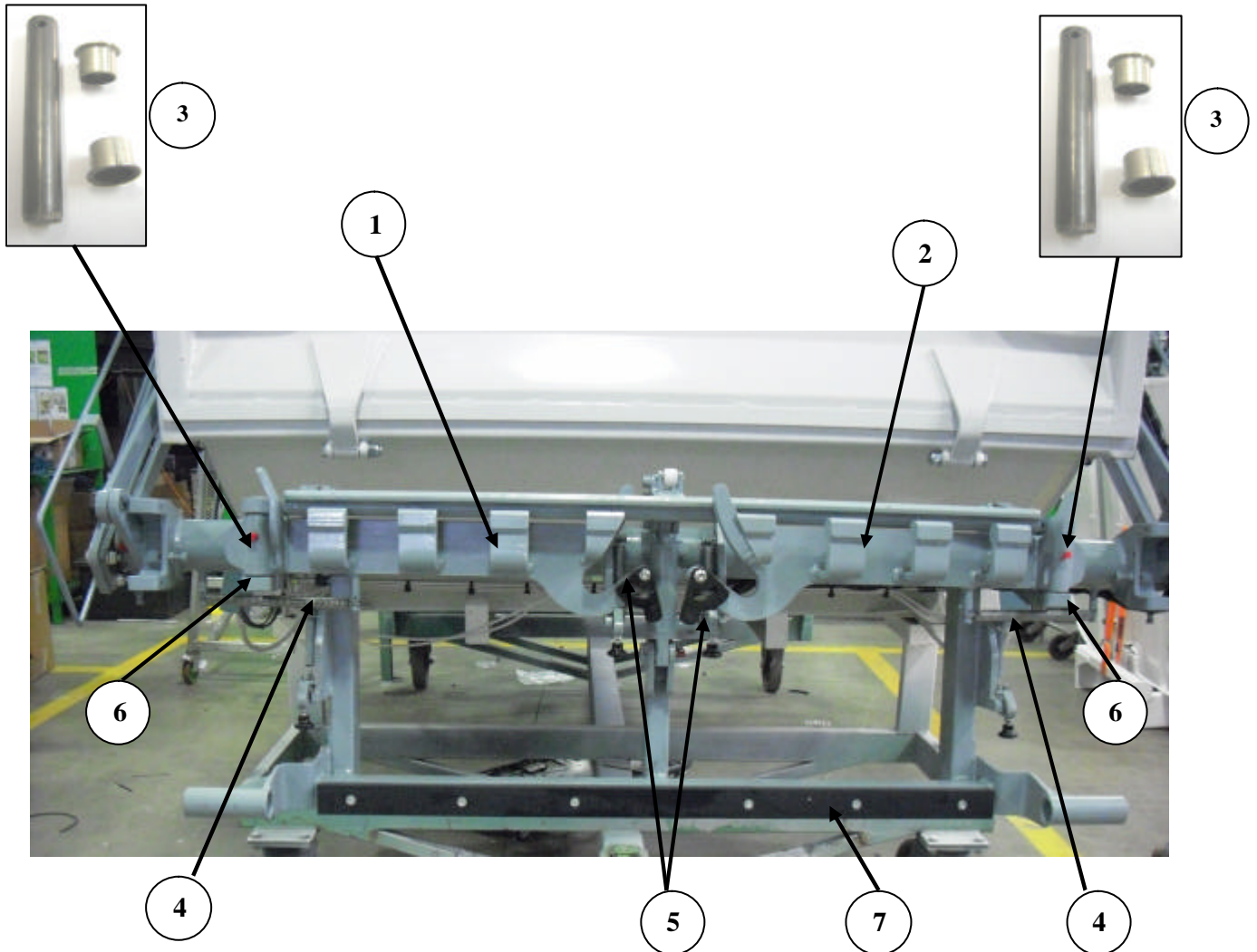

TAV	POS	CODICE / CODE	DESCRIZIONE	DESCRIPTION	Q.TY	NOTE
T1CH	1	03220005260	BRACCIO SINISTRO	ARM - LEFT	1	Lt. 1100
T1CH	2	03220005267	BRACCIO DESTRO	ARM - RIGHT	1	Lt. 1100
T1CH	3	08010001281	PERNO - BRACCIO	PIN FOR ARM	2	
		08170001118	BOCCOLA	BUSH	4	
T1CH	4	08300001064	MOLLA	SPRING	2	PER BRACCI 1100 DIN FOR ARMS-1100 DIN
T1CH	5	03220005234	PENDOLO SICUREZZA	SAFETY PENDULUM	2	DESTRO-RIGHT
		03220005234			2	SINISTRO - LEFT
T1CH	6	03220005273	MAGNONE BRACCI	SUPPORT ARMS	2	
T1CH	7	03220003088	RISCONTRO PVC	PVC-LIMIT-STIOP	1	

PAGINA 1 di 2
SHEET 1 of 2

TAV.T1CH

FARID Industrie S.p.A

C – PETTINE PER VOLTACONTENITORI Lt 1100 DIN –EVO4
COMB FOR BIN LIFT Lt. 1100 DIN – EVO4

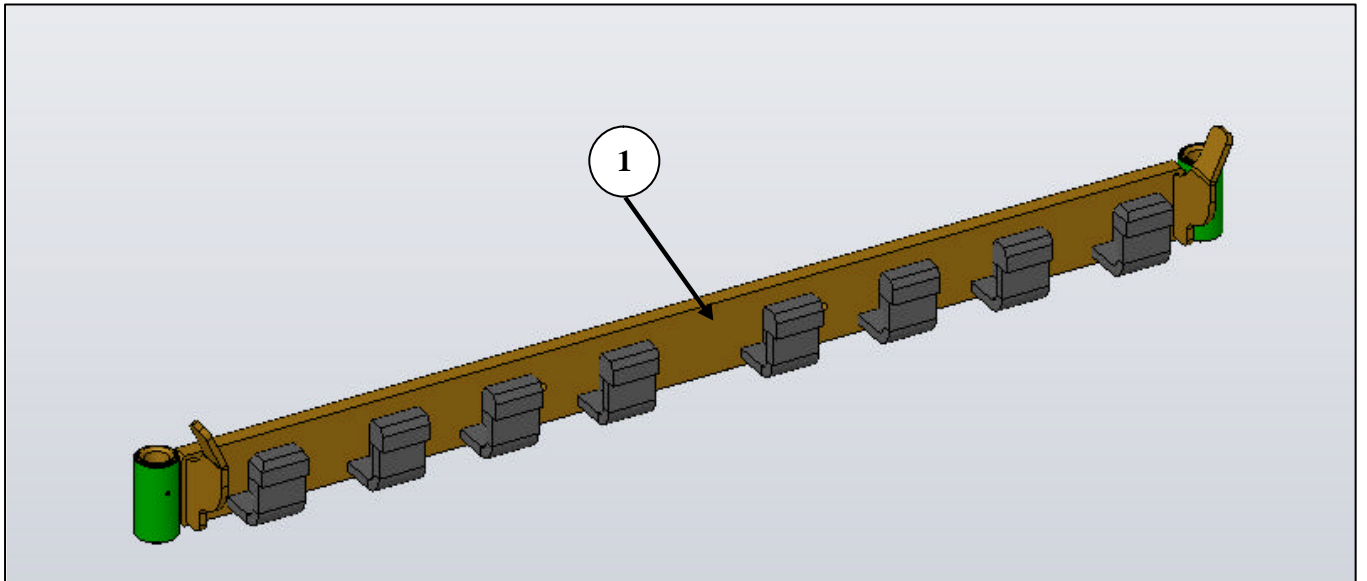

TAV	POS	CODICE / CODE	DESCRIZIONE	DESCRIPTION	Q.TY	NOTE
T1CH	1	03220005615	PETTINE	COMB	1	

PAGINA 2 di 2
SHEET 2 of 2

TAV.T1CH

FARID Industrie S.p.A

PROTEZIONI LATERALI

LATERAL PROTECTION

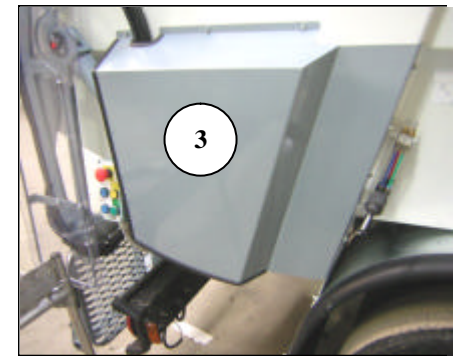
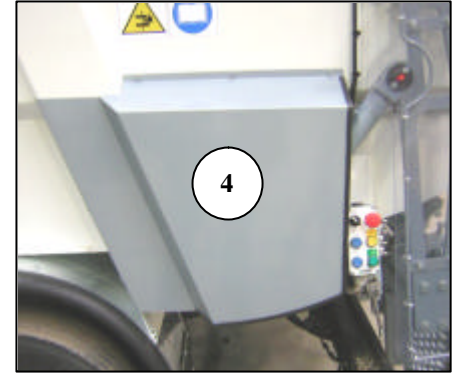
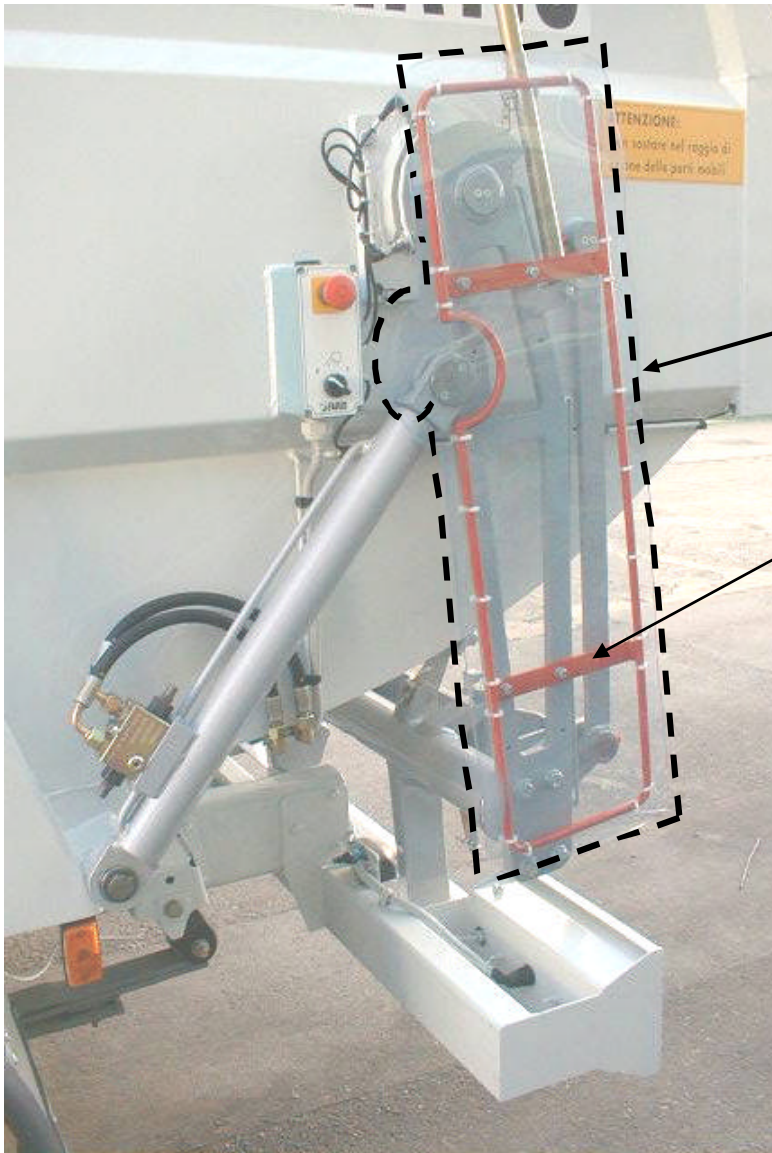

TAV	POS	CODICE / CODE	DESCRIZIONE	DESCRIPTION	Q.TY	NOTE
T1D	1	08330001053	PROTEZIONE PVC	PVC PROTECTION	2	
T1D	2	03130001128	SUPPORTO PROTEZIONE PVC	SUPPORT PVC PROTECTION	1	DESTRO RIGHT
		03130001129			1	SINISTRO LEFT
T1D	3	03270001083	CARTER DESTRO	CARTER RIGHT		OPTIONAL
T1D	4	03270001082	CARTER SINISTRO	CARTER LEFT		OPTIONAL

TAV.T1D

FARID Industrie S.p.A

PALA COMPATTAZIONE PACKER PLATE

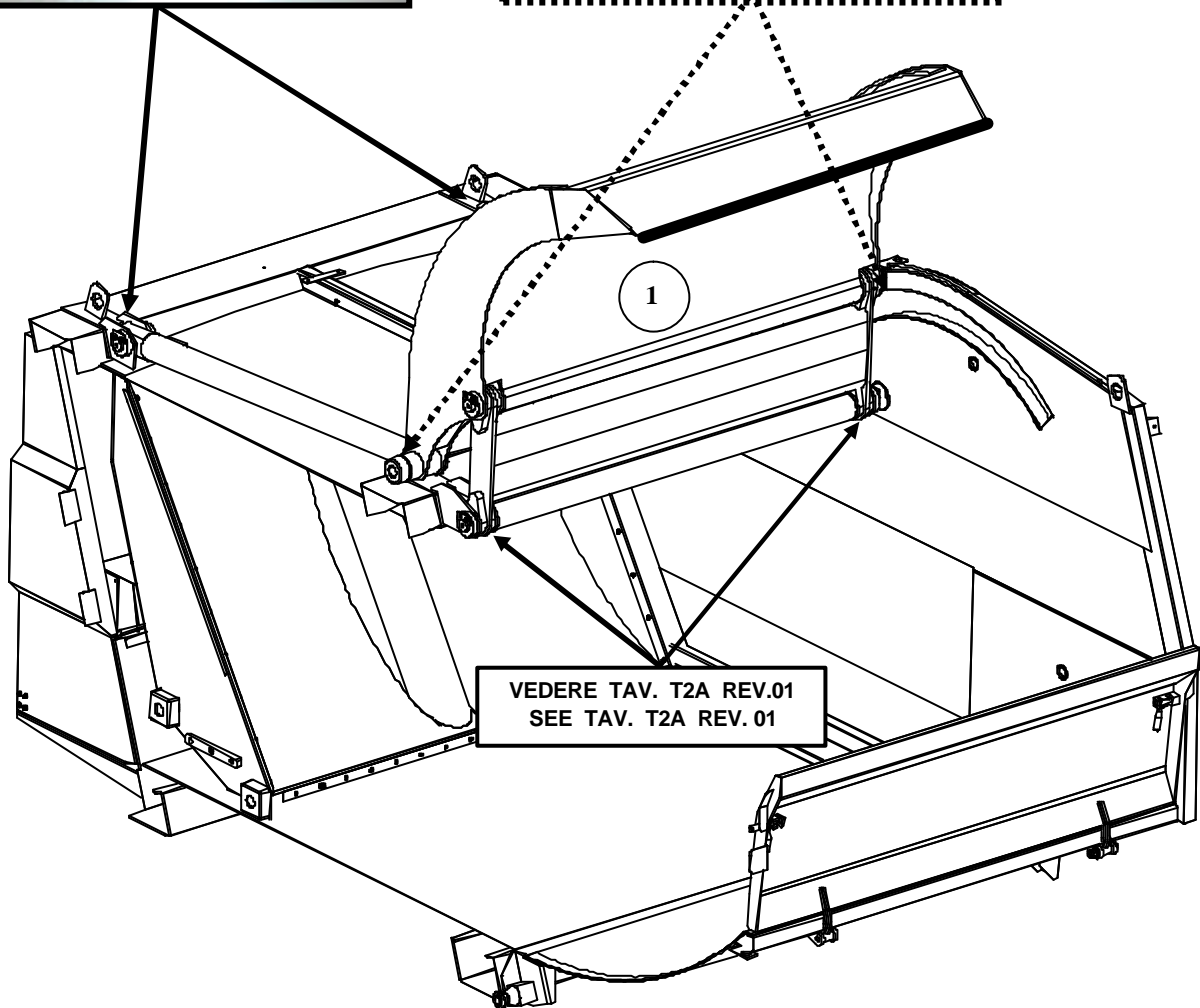
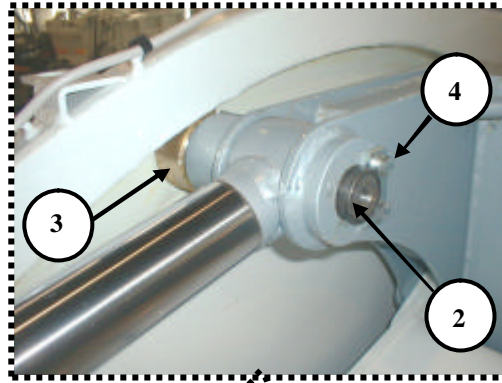
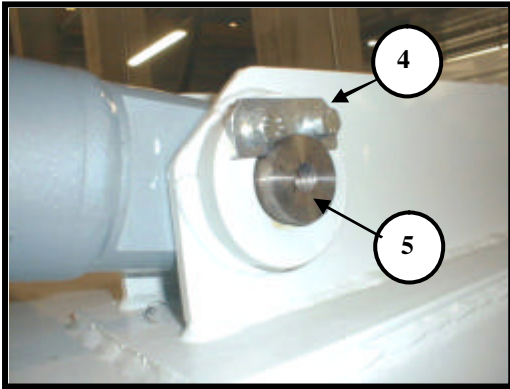

TAV	POS	CODICE / CODE	DESCRIZIONE	DESCRIPTION	Q.TY	NOTE
T2	1	03100001394	PALA	PACKER PLATE	1	CON DENTE DA 50 mm WITH PLATE OF 50 mm
T2	2	03100001369	PERNO	PIN	2	COMPLETO DI PIASTRINA COMPLETE WITH PLATE
T2	3	03100001325	RULLO	ROLLER	2	
T2	4	03090001348	PIASTRINA PER PERNO	PLATE FOR PIN	6	
T2	5	03100001370	PERNO	PIN	4	COMPLETO DI PIASTRINA COMPLETE WITH PLATE

TAV.T2

FARID Industrie S.p.A

BIELLINO PER PALA
CONNECTING ROD FOR PACKER PLATE

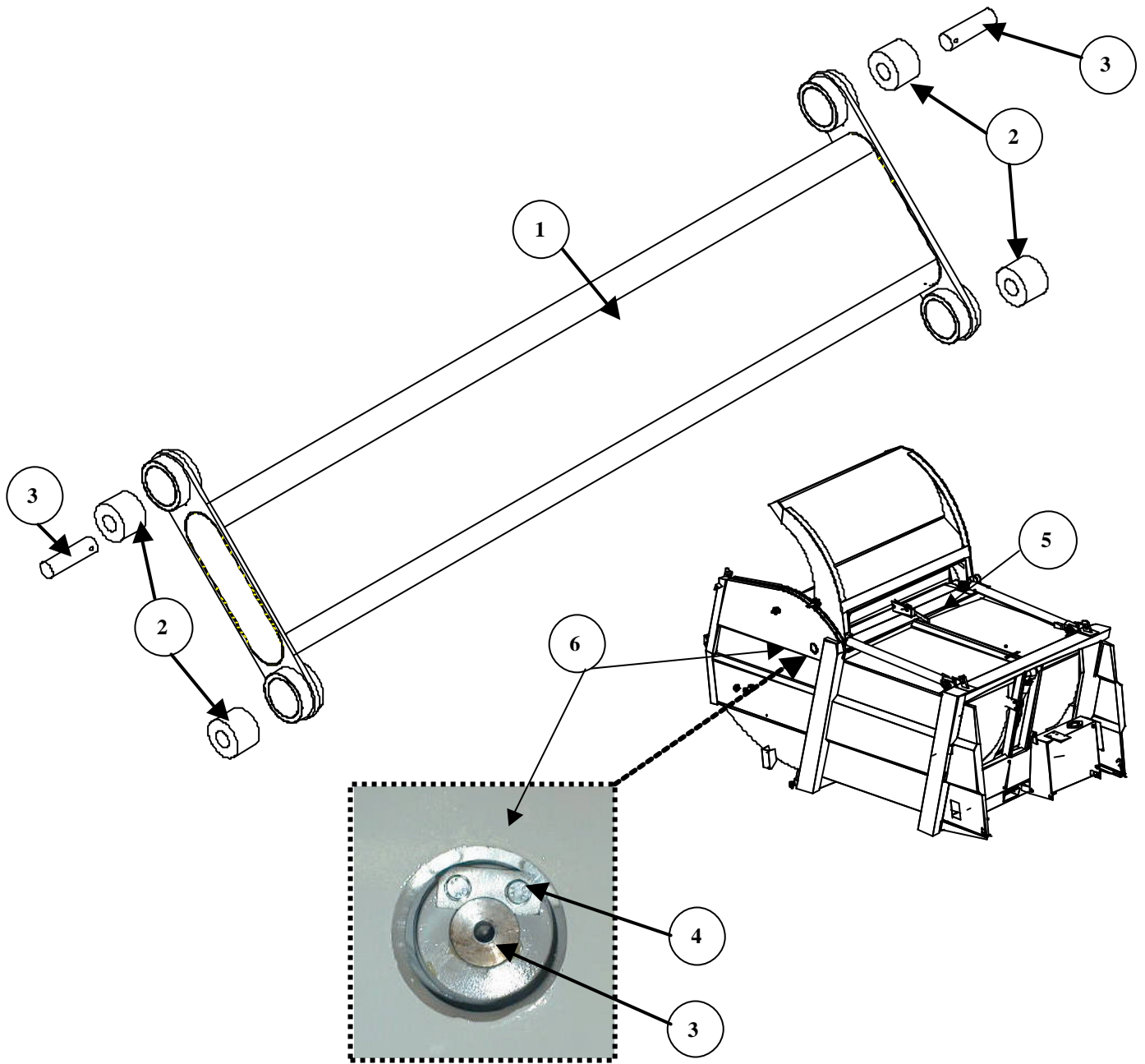

TAV	POS	CODICE / CODE	DESCRIZIONE	DESCRIPTION	Q.TY	NOTE
T2A	1	03100001326	BIELLINO	CONNECTING ROD	1	COMPLETO DI BOCCOLE COMPLETE WITH BUSHS
T2A	2	03100001327	BOCCOLA	BUSH	4	
T2A	3	03100001370	PERNO	PIN	2	
T2A	4	03090001348	PIASTRINA PER PERNO	PLATE FOR PIN	2	
T2A	5	03010003164	TERMINALE TETTO	TERMINAL ROOF	1	COMPLETO DI ATTACCHI COMPLETE WITH JUNCTIONS
T2A	6	09030001243	TAPPO CHIUSURA IN PLASTICA	PLASTIC PLUG	2	

**PARATIA ESPULSIONE
EJECTION PLATE**

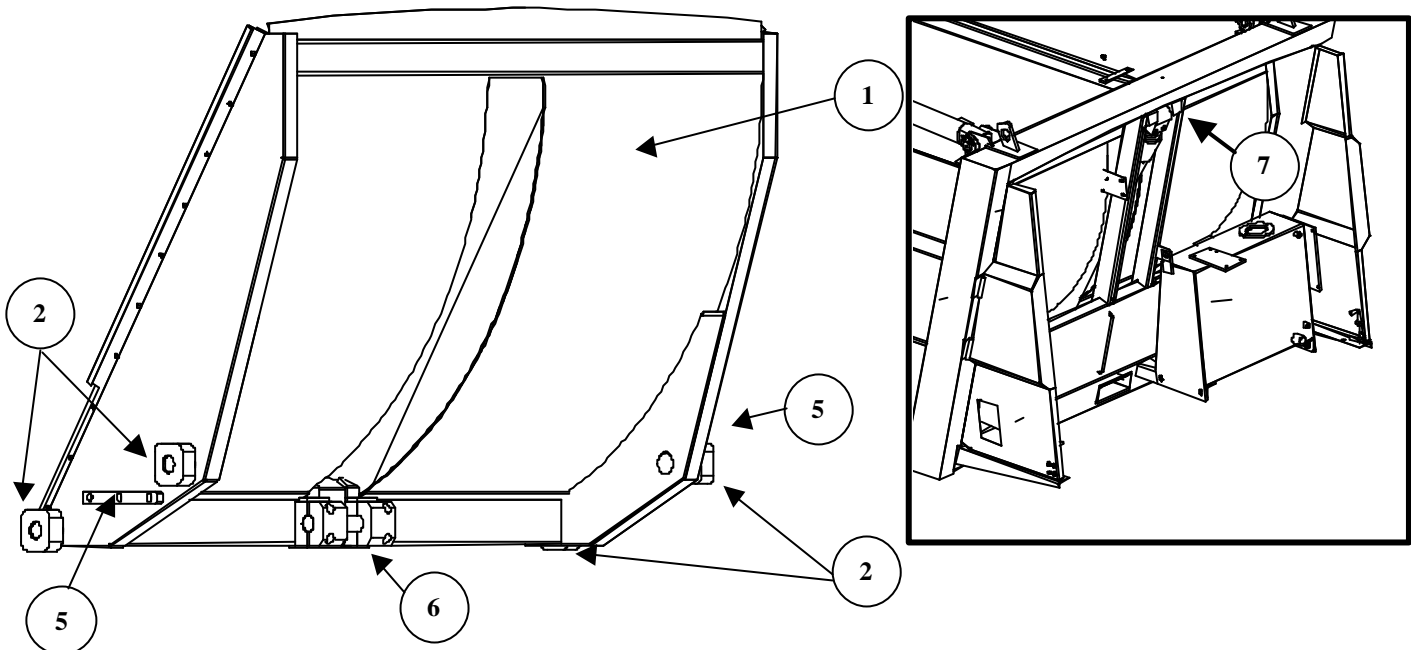
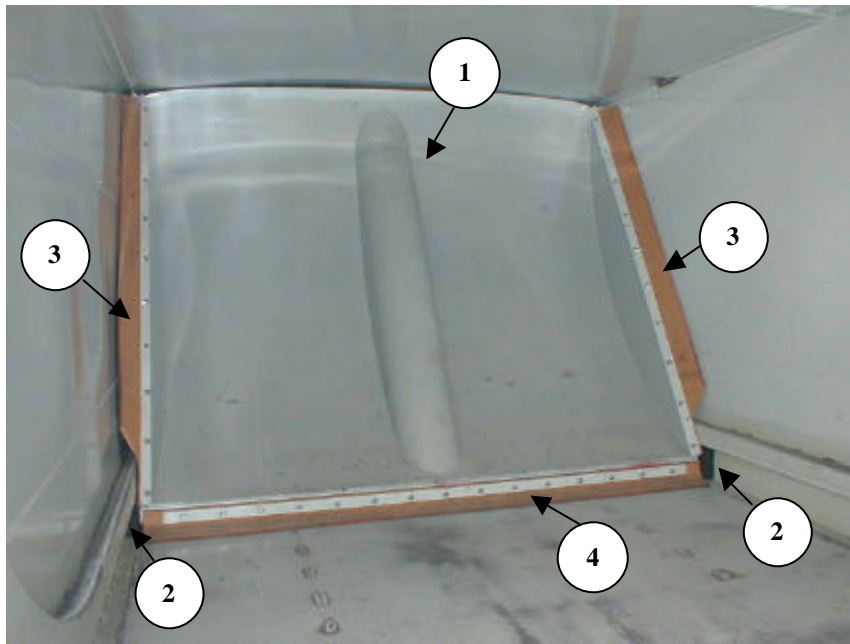

TAV	POS	CODICE / CODE	DESCRIZIONE	DESCRIPTION	Q.TY	NOTE
T3	1	03110001525	PARATIA	EJECTION PLATE	1	
T3	2	08250001139	PATTINO SCORR.	PAD	4	
T3	3	08120001048	KIT GUARNIZIONE-LATERALE	KIT LATERAL SEAL	2	
T3	4	08120001049	KIT GUARNIZIONE-INFERIORE	KIT INFERIOR SEAL	1	
T3	5	08250001149	PATTINO LATERALE	LATERAL PAD	2	
T3	6	08010001273 08010001390	PERNO INFERIORE PERNO INF. INOX	INFERIOR PIN INOX-INF. PIN	1	OPTIONAL
T3	7	08010001272	PERNO SUPERIORE	SUPERIOR PIN	1	

**PER POSIZIONI 3-4 E' POSSIBILE ORDINARE LA GUARNIZIONE SCIOLTA A METRI
FOR POSITION 3-4 IS POSSIBLE ORDER THE SEAL IN METERS CODICE/CODE : 08180001051**

SPONDINA POSTERIORE REAR FLAP

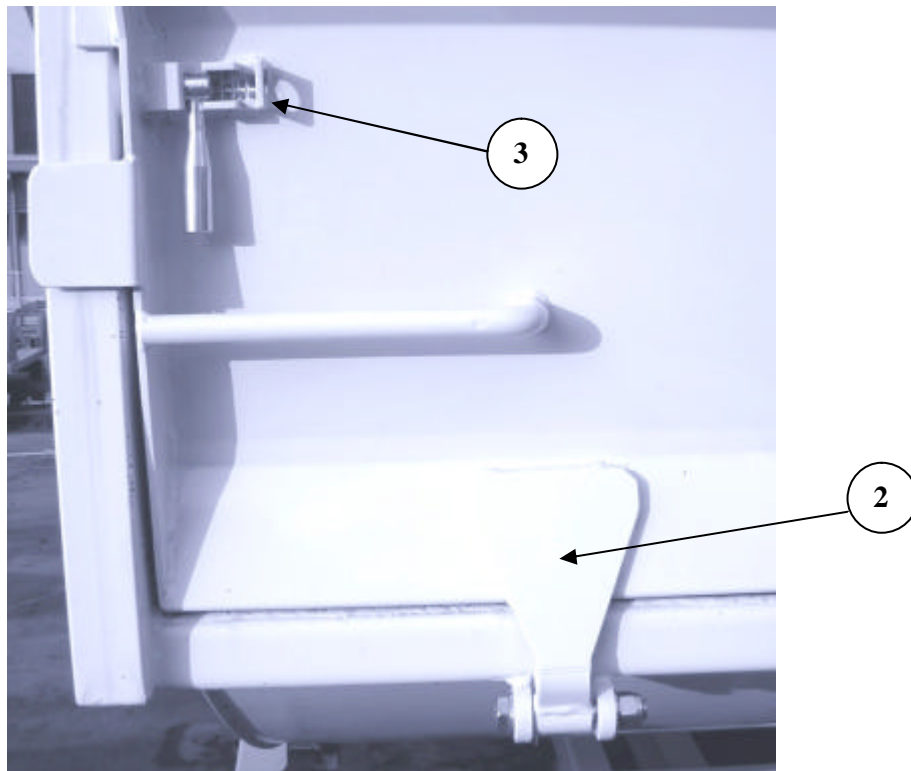
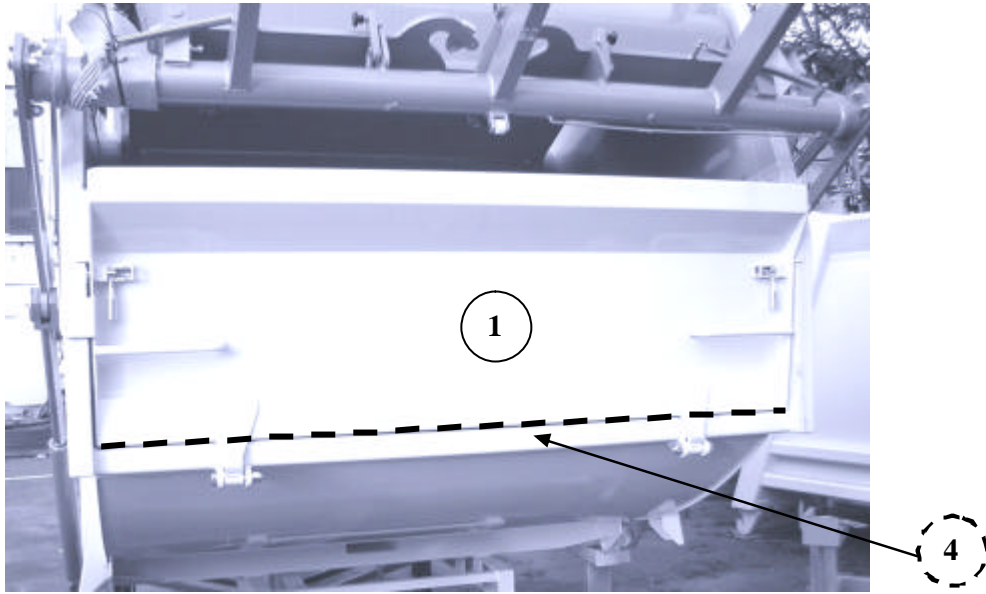

TAV	POS	CODICE / CODE	DESCRIZIONE	DESCRIPTION	Q.TY	NOTE
T4	1	03190001226	SPONDINA	REAR FLAP	1	COMPLETA-COMLETE
T4	2	03190001340	CERNIERA	HINGE	2	
T4	3	03190001045	CHIAVISTELLO	DOOR LATCH	2	
T4	4	03190001227	GUARNIZIONE INTERNA	INTERNAL SEAL	1	OPTIONAL L = 170 Cm

SERBATOIO OLIO E ACCESSORI
OIL TANK AND ACCESSORIES

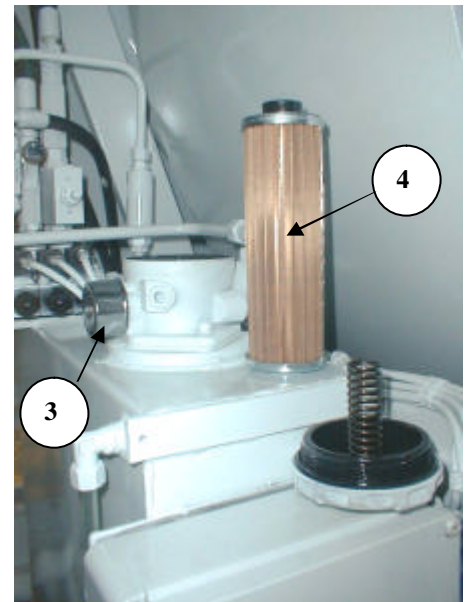
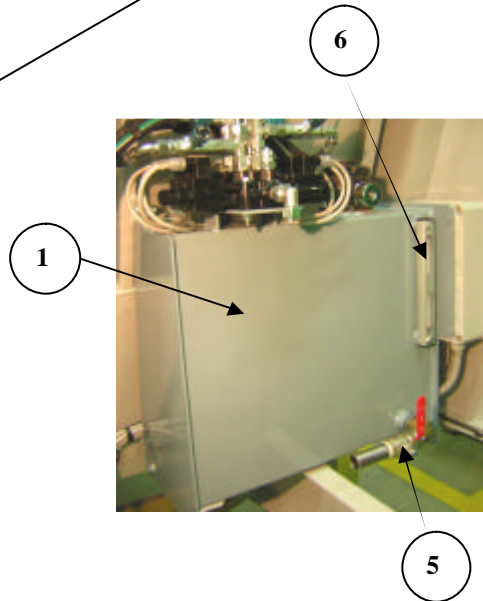
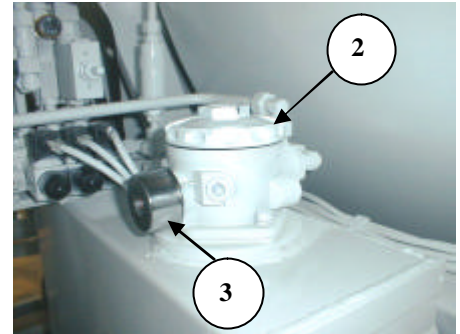
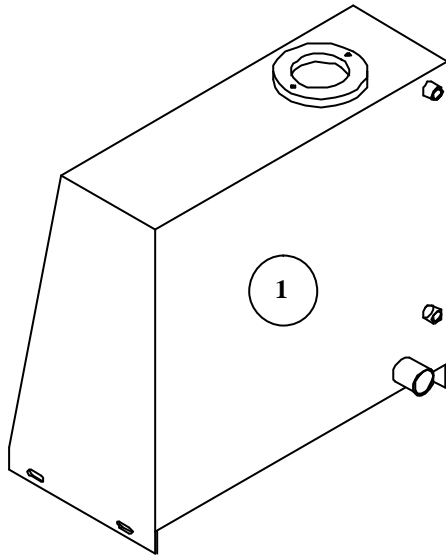

TAV	POS	CODICE / CODE	DESCRIZIONE	DESCRIPTION	Q.TY	NOTE
T5	1	03160001246	SERBATOIO OLIO	OIL TANK	1	
T5	2	04140001206	FILTRO OLIO COMPLETO	OIL FILTER COMPLETE	1	
T5	3	06110001016	FILTRO ARIA CARTUCCIA	AIR FILTER CARTRIDGE FOR	1	
T5	4	04140001207	CARTUCCIA FILTRO	CARTRIDGE	1	
T5	5	04060001025	SARACINESCA 1"	VALVE 1"	1	
T5	6	04110001058	LIVELLO OLIO	OIL LEVEL	1	
T5		12020001033	OLIO IDRAULICO	HYDRAULIC OIL		

BARRA APRICOPERCHIO **COVER BIN BAR**

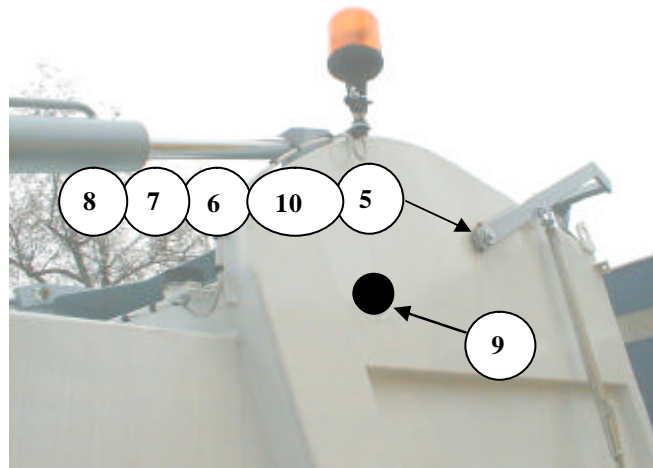
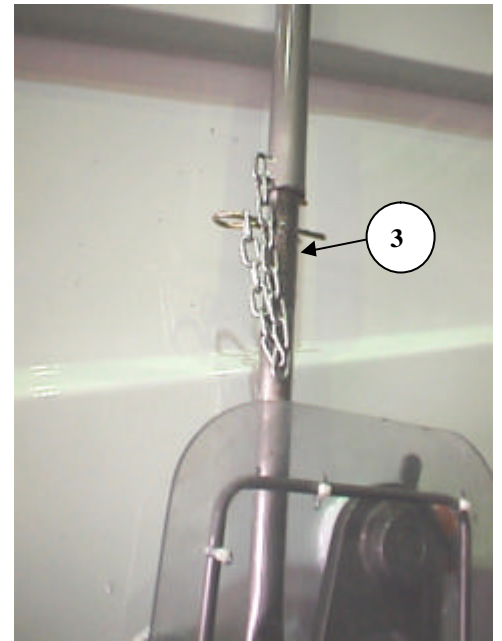
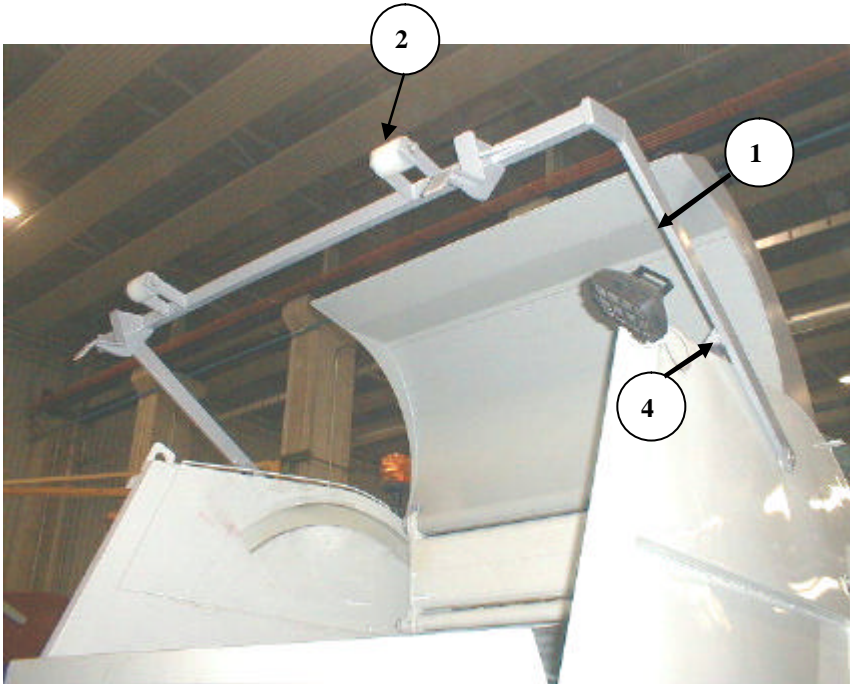

TAV	POS	CODICE / CODE	DESCRIZIONE	DESCRIPTION	Q.TY	NOTE
T11	1	03020001203	BARRA	BAR	1	
T11	2	03020001209	RULLO NYLON	ROLLER	2	
T11	3	03020001204	KIT-BARRA	KIT-BAR	1	
T11	4	08230001024	TAMPONE GOMMA	RUBBER	2	
T11	5	03020001237	PERNO SALDATO	PIN-WELDED	2	COMPLETO DI RONDELLA COMPLETE WITH WASHER
T11	6	08060001286	RONDELLA	WASHER	2	
T11	7	08020001955	VITE	SCHREW	2	
T11	8	08240001006	INGRASSATORE	GREASE NIPPLE	2	
T11	9	09030001243	TAPPO IN PLASTICA	PLASTIC PLUG	2	
T11	10	08160001527	BOCCOLA INTERNA	INTERNAL BUSH	2	

TAV.T11

FARID Industrie S.p.A

DISPOSITIVO APRICOPERCHIO COVER BIN BAR DEVICE

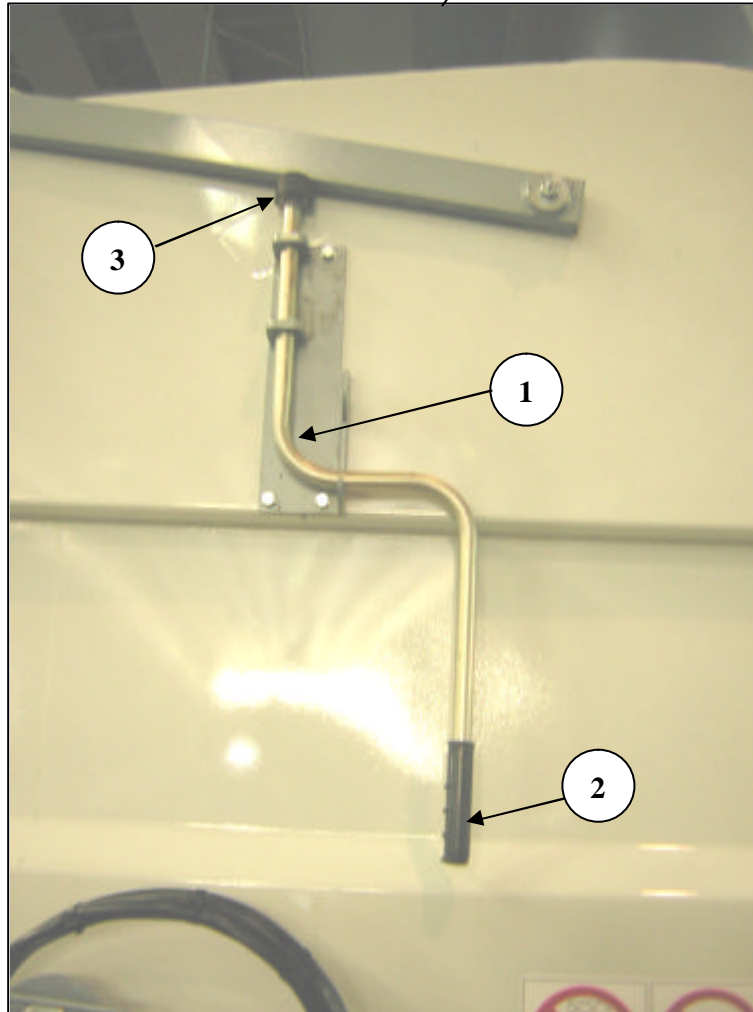
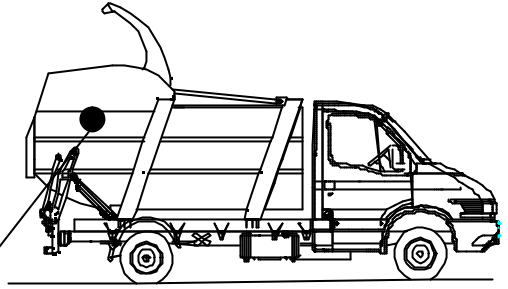

TAV	POS	CODICE / CODE	DESCRIZIONE	DESCRIPTION	Q.TY	NOTE
	1	03020001247	DISPOSITIVO	DEVICE	1	ASTA + SUPPORTO LEVER + SUPPORT
	2	09020001040	MANOPOLA PLASTICA	PLASTIC-HANDLE- GRIP	1	
	3	08230001024	TAMPONE GOMMA	RUBBER	1	

**ACCESSORI
ACCESSORIES**

NOTE : AS FAR AS THE ADHESIVE ONES IN PHASE OF ORDER I PRAY TO SPECIFY THE LANGUAGE TO USE

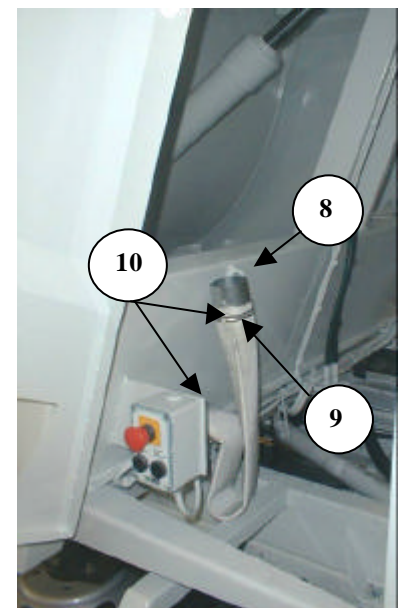
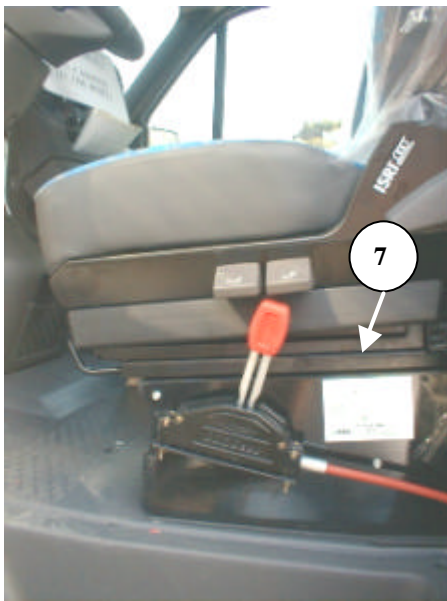
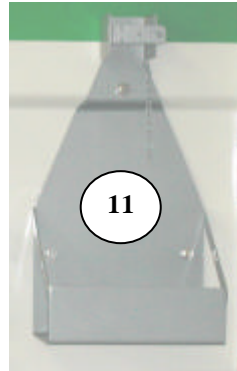
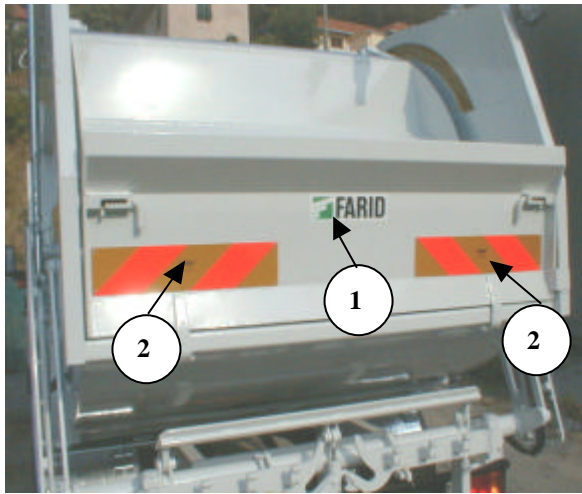

TAV	POS	CODICE / CODE	DESCRIZIONE	DESCRIPTION	Q.TY	NOTE
T20	1	08280001278	TARGA FARID	FARID PLATE	3	
T20	2	05060001084	PANNELLI RETROREFLETTENTI	PLATE BACK REFLECTING	2	
T20	3	08280002401	TARGHETTA	PLATE	2	IN ITALIANO - IN ITALIAN
T20	4	08280001332	TARGHETTA	PLATE	2	IN ITALIANO - IN ITALIAN
T20	5	08280001410	TARGA MINIMATIC	MINIMATIC PLATE	2	
T20	6	09030001140	PARASPRUZZI	SPLASH GUARD	2	
T20	7	08280001401	TARGHETTA	PLATE	1	
T20	8	03240001013	ESTREMITA' MOBILE	END	1	
T20	9	04100001142	TUBO TELATO	HOSE	1	
T20	10	04170001065	FASCETTA	CLAMP	2	
T20	11	09020001037	PORTASCOPE	SUPPORT FOR BROOM	1	OPTIONAL

ACCESSORI ACCESSORIES

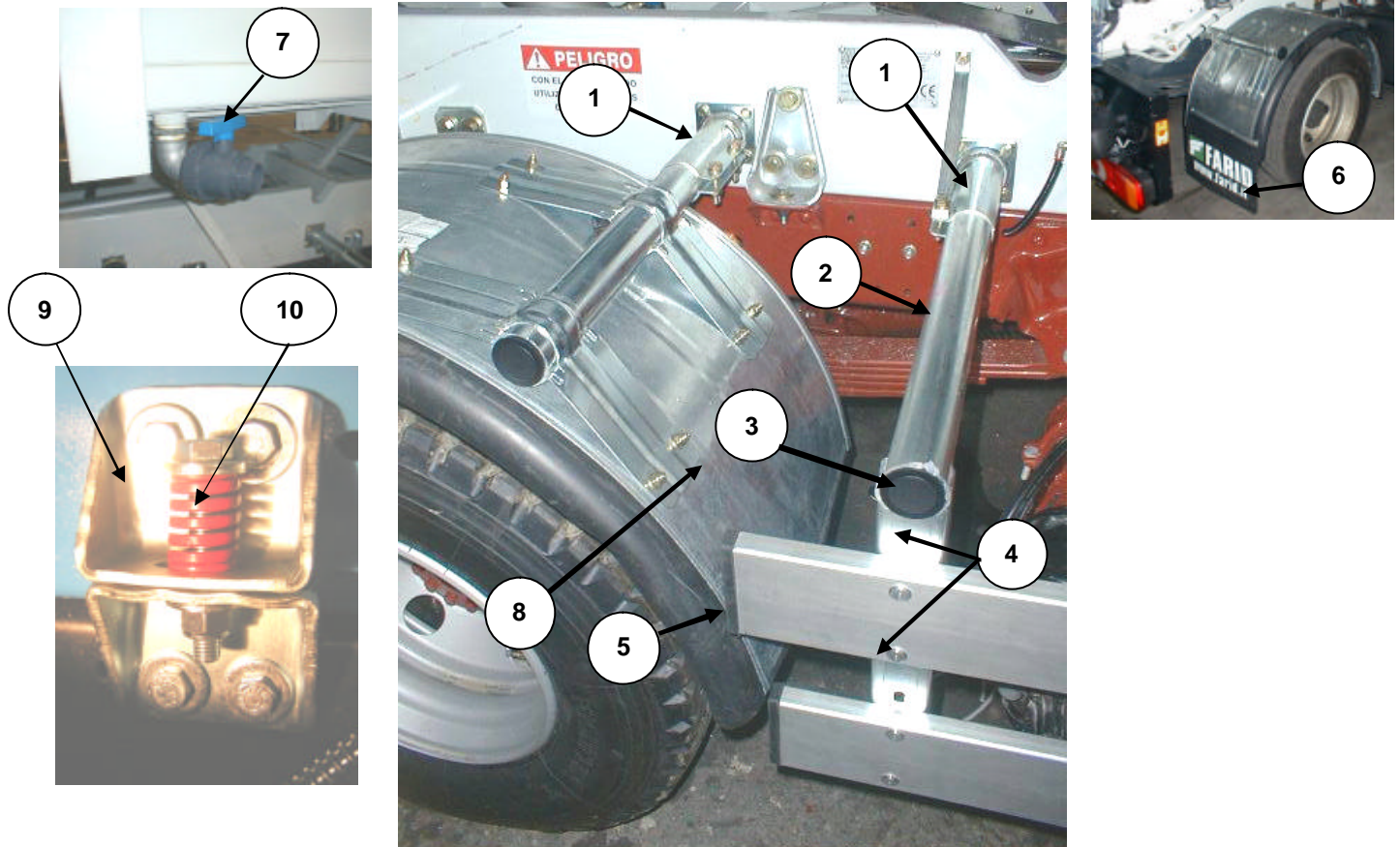

TAV.	POS	CODICE/CODE	DESCRIZIONE	DESCRIPTION	Q.TY	NOTE
T20A	1	09030001092	SUPPORTO STAFFA PARACICLISTI	SUPPORT FOR SECURITY CYCLE	4	
		09030001212	SUPP. CON MASSELLO		4	
T20A	2	09030001086	STAFFA PARACICLISTI	SUPPORT	4	
T20A	3	09030001080	TAPPO IN PLASTICA	PLASTIC PLUG	4	
T20A	4	09030001135	PROFILATO PARACICLISTI	SECTION FOR SECURITY CICLE		ORDINARE IN metri ORDER IN MEASURE mt
T20A	5	09030001136	TAPPO CHIUSURA PROFILATO	PLUG		
T20A	6	09030001140	PARASPRUZZI	MUDFLAP	2	
T20A	7	04060001016	VALVOLA SCARICO LIQUAMI	VALVE - DIRTY WATER	1	
		04050001392	NIPPLO ZINCATO	NIPPLE ZINC.	1	
		04050001449	GOMITO ZINCATO	BEND 90° ZINC.	1	
T20A	8	09030001130	PARAFANGO	MUDGUARD	2	L= 475 x 1600
T20A	9	08260001153	PIASTRA	PLATE	/	
T20A	10	08300001124	MOLLA	SPRING	/	R32-051
		08060001243	RONDELLA	WASHER	/	14x35 sp 5
		08020001370	VITE	SCREW	/	M12x1.25 10.9
		08030001105	DADO	NUT	/	M12
T20A		12030001002	GRASSO PER LUBRIFICAZIONE ATTREZZATURA	GREASE FOR BODY		

**TARGHE ADESIVE IN INGLESE
ENGLISH ADHESIVE LABEL**

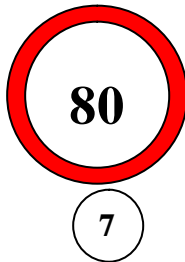
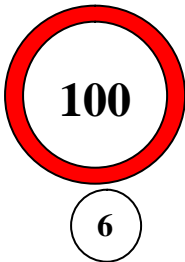
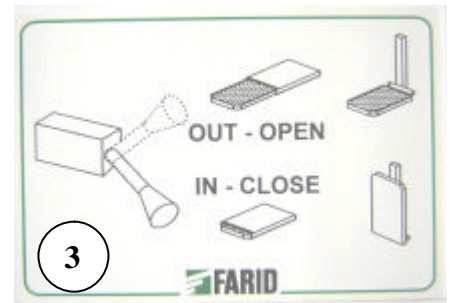
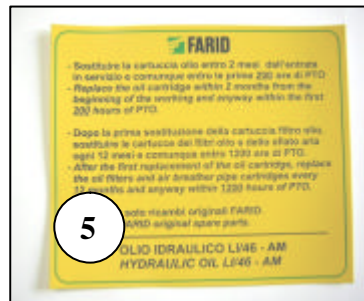
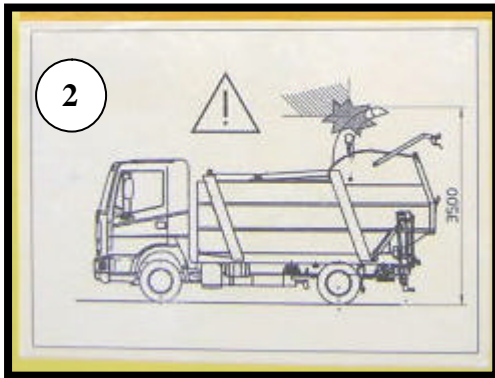
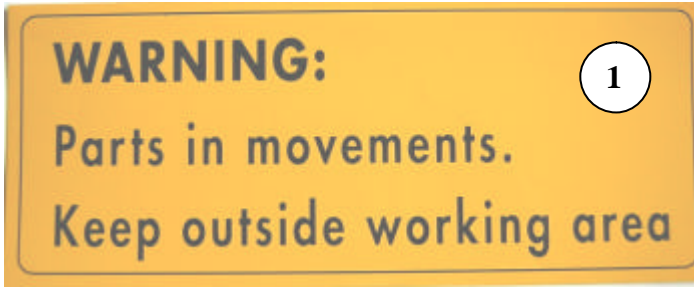

TAV/ TAB	POS	CODICE / CODE	DESCRIZIONE	DESCRIPTION	Q.TY	NOTE
T20B	1	08280001336	TARGA ADESIVA	LABEL	2	
T20B	2	08280002617	TARGA ADESIVA	LABEL	1	
T20B	3	08280002507	TARGA ADESIVA	LABEL	1	
T20B	4	08280002582	TARGA ADESIVA SICUREZZE	LABEL SECURITY	2	
T20B	5	08280002650	TARGA OLIO IDRAULICO	PLATE HYDRAULIC OIL	1	
T20B	6	09020001056	TARGA VELOCITA' 100 Km	PLATE - SPEED 100 Km	1	
T20B	7	08280001023	TARGA VELOCITA' 80 Km	PLATE - SPEED 80 Km	1	
T20B	8	08280001346	TARGA CE	PLATE CE	1	
T20B	9	08280000015	TARGA PEDANE	PLATFORMS - LABEL	2	

IDRAULICA

HYDRAULIC

CILINDRO PARATIA ESPULSIONE CYLINDER FOR EJECTION PLATE

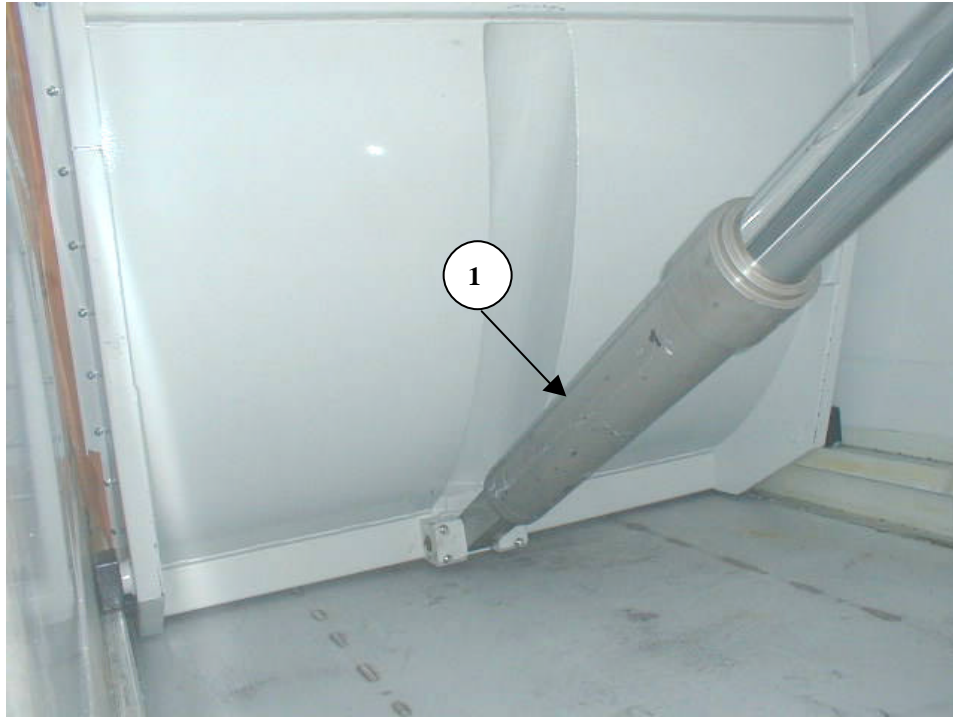

TAV	POS	CODICE / CODE	ATTREZZATURA	BODY	Q.TY	NOTE
T6	1	04070001836 04120002474	MINIMATIC 6 KIT GUARNZIONI	MINIMATIC 6 SEAL	1 1	
T6	1	04070001837 04120002474	MINIMATIC 7 KIT GUARNZIONI	MINIMATIC 7 SEAL	1 1	
T6	1	04070001839 04120002243	MINIMATIC 8 KIT GUARNZIONI	MINIMATIC 8 SEAL	1 1	MM 8 E MM8 RIBASSATO MM8 AND MM8 LOW LEVEL

CILINDRI PALA
CYLINDERS FOR PACKER PLATE

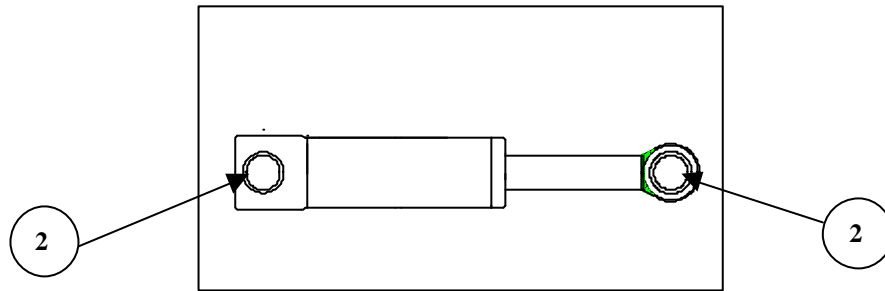

TAV	POS	CODICE / CODE	ATTREZZATURA	BODY	Q.TY	NOTE
T7	1	04070001871	MINIMATIC 6	MINIMATIC 6	2	
		04120002170	KIT-GUARNIZIONI	SEAL	2	
T7	1	04070001871	MINIMATIC 7	MINIMATIC 7	2	
		04120002170	KIT-GUARNIZIONI	SEAL	2	
T7	1	04070001872	MINIMATIC 8	MINIMATIC 8	2	
		04120002171	KIT-GUARNIZIONI	SEAL	2	
T7	2	08160001524	BOCCOLA	BUSH	2+2	

CILINDRI VOLTACONTENITORI (MINIMATIC 6/7/8) CYLINDERS FOR BIN LIFT (MINIMATIC 6/7/8)

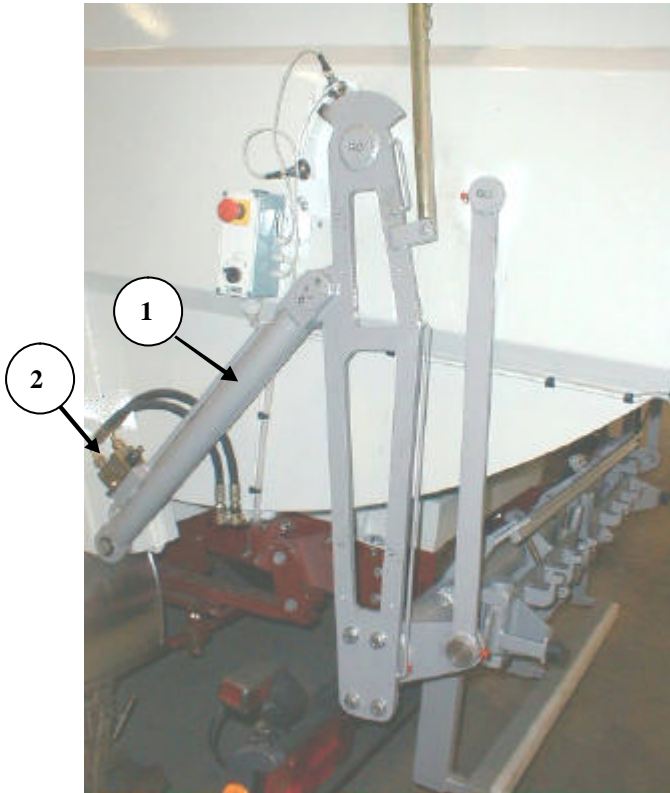

TAV	POS	CODICE / CODE	DESCRIZIONE	DESCRIPTION	Q.TY	NOTE
T8	1	04070001840	CILINDRO	CYLINDER	2	COMPLETO COMPLETE
T8	1	04070001830	CILINDRO	CYLINDER	2	SENZA VALVOLA BLOCCO WITHOUT SAFETY VALVE
T8	1	04120002473	KIT - GUARNIZIONI	SEAL	2	

TAV	POS	CODICE	DESCRIZIONE	DESCRIPTION	Q.TY	NOTE
T8	2	04040001639	VALVOLA BLOCCO	SAFETY VALVE	2	

TAV	POS	CODICE	DESCRIZIONE	DESCRIPTION	Q.TY	NOTE
T8	3	04040001411	VALVOLA	VALVE	1	PRESENTE SOLO
		04040001640	CURSORE VALVOLA	CURSOR VALVE	2	CON PETTINE
		05080001161	ELETTROV.- 12V	SOLENOID -12V	2	ONLY PRESENT
		04040001217	ELETTROV.- 24V	SOLENOID -24V	2	WITH MOVING
		05080001170	CONNETTORE	CONNECTOR	2	FRAME

CILINDRI VOLTACONTENITORI (MINIMATIC 6/7/8)
CYLINDERS FOR BIN LIFT (MINIMATIC 6/7/8)

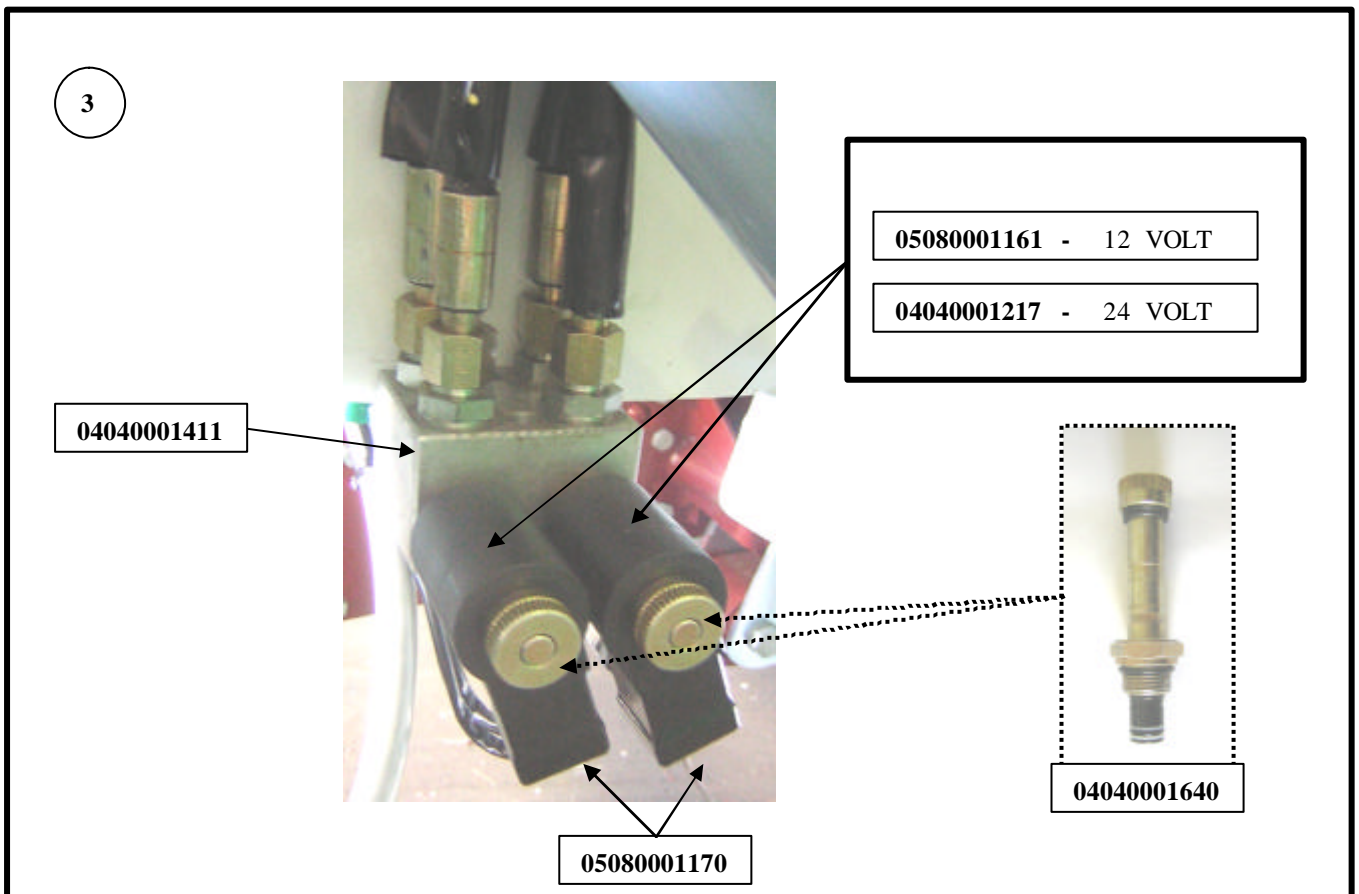
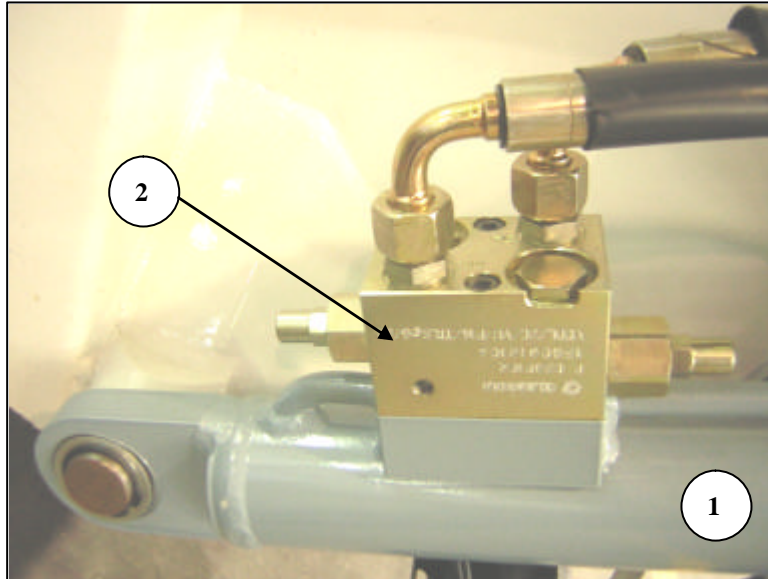

CILINDRO PETTINE CYLINDER FOR MOVING FRAME

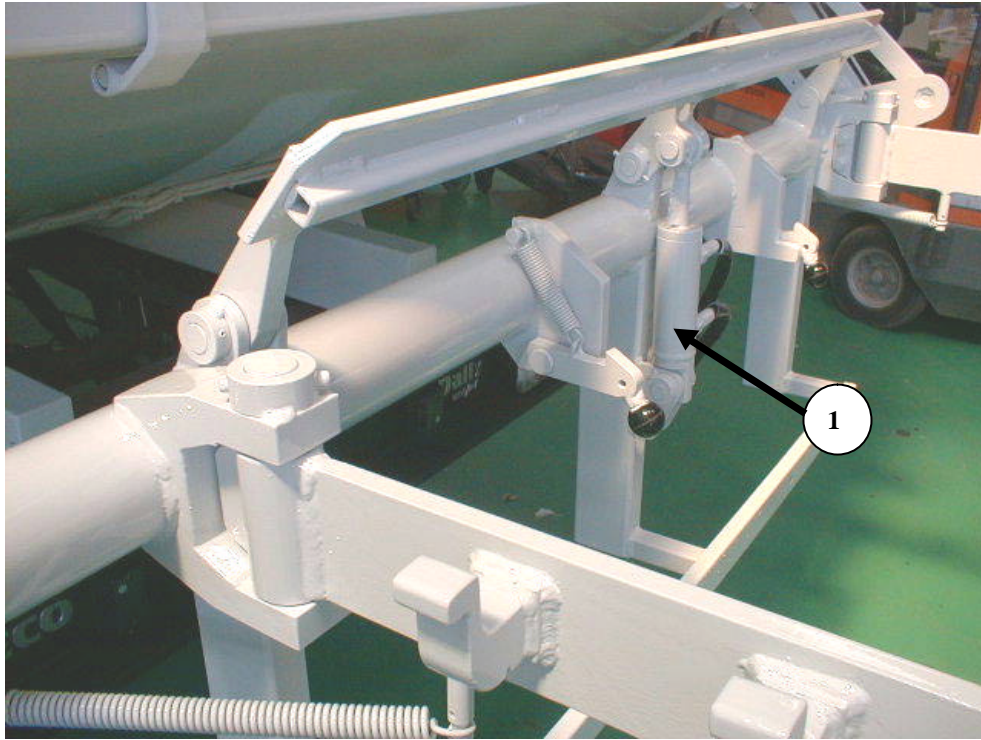

TAV	POS	CODICE / CODE	ATTREZZATURA	BODY	Q.TY	NOTE
T9	1	04070001831	MINIMATIC 6	MINIMATIC 6	1	
		04120002029	KIT-GUARNIZIONI	SEAL	1	
T9	1	04070001831	MINIMATIC 7	MINIMATIC 7	1	
		04120002029	KIT-GUARNIZIONI	SEAL	1	
T9	1	04070001831	MINIMATIC 8	MINIMATIC 8	1	
		04120002029	KIT-GUARNIZIONI	SEAL	1	

DISTRIBUTORE IDRAULICO (3 LEVE) OIL DISTRIBUTOR (3 LEVERS)

VISTA LATO SINISTRO
VIEW ON THE LEFT SIDE

VISTA LATO DESTRO
VIEW ON THE RIGHT SIDE

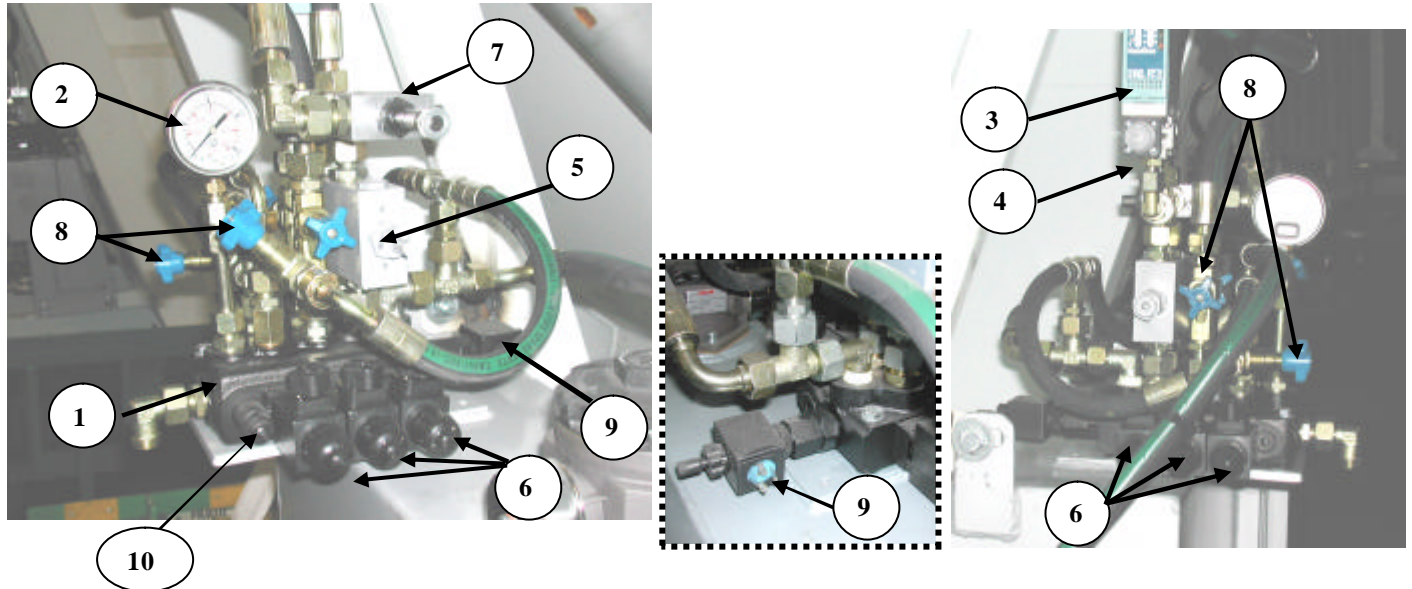

TAV	POS	CODICE/CODE	DESCRIZIONE	DESCRIPTION	Q.TY	NOTE
T10	1	04010001368 04010001367	DISTRIBUTORE IDRAULICO	HYDRAULIC DISTRIBUTOR	1	COMPLETO-COMLETE 24V COMPLETO-COMLETE 12V
T10	2	04110001006	MANOMETRO	MANOMETER	1	
T10	3	04130001004	PRESSOSTATO	PRESSURE SWITCH	1	
T10	4	04130001003	CONNETTORE PRESSOSTATO	PRESSURE CONNECTOR	1	
T10	5	04040001562	VALVOLA	VALVE	1	
T10	6	04010001395 04010001396 05080001003 04010001397	ELETTOVALV.- 12V ELETTOVALV.- 24V CONNETTORE CURSORE+ KIT ORING E GHIERA	SOLENOID -12V SOLENOID -24V CONNECTOR CURSOR + KIT ORING AND RING NUT	6 6 6 6	
T10	7	04040001569 05080001161 04040001217 05080001003	VALVOLA BOBINA-12V BOBINA-24V CONNETTORE	VALVE SOLENOID -12V SOLENOID-24V CONNECTOR	1 1 1	
T10	8	04040001361	STROZZATORE	THROAT	4	
T10	9	04090001007 04040001626 04040001625 05080001003	CURSORE-BYPASS BOBINA-12V BOBINA-24V CONNETTORE	BY-PASS-CURSOR SOLENOID -12V SOLENOID-24V CONNECTOR	1 1 1 1	TIPO QUADRATA-SQUARE FORM TIPO QUADRATA-SQUARE FORM
T10	10	04040001708	VALVOLA DI MASSIMA	MAX VALVE	1	

NOTA : IL LATO DESTRO O SINISTRO E' DATO DALLA VISTA POSTERIORE
GUARDANDO IL SENSO DI MARCIA DEL VEICOLO

NOTE : THE RIGHT AND LEFT SIDE IS GIVEN BY REAR SIGHT LOOKING AT
THE SENSE OF MARCH OF THE VEICLE

DISTRIBUTORE IDRAULICO (3 LEVE)
OIL DISTRIBUTOR (3 LEVERS)

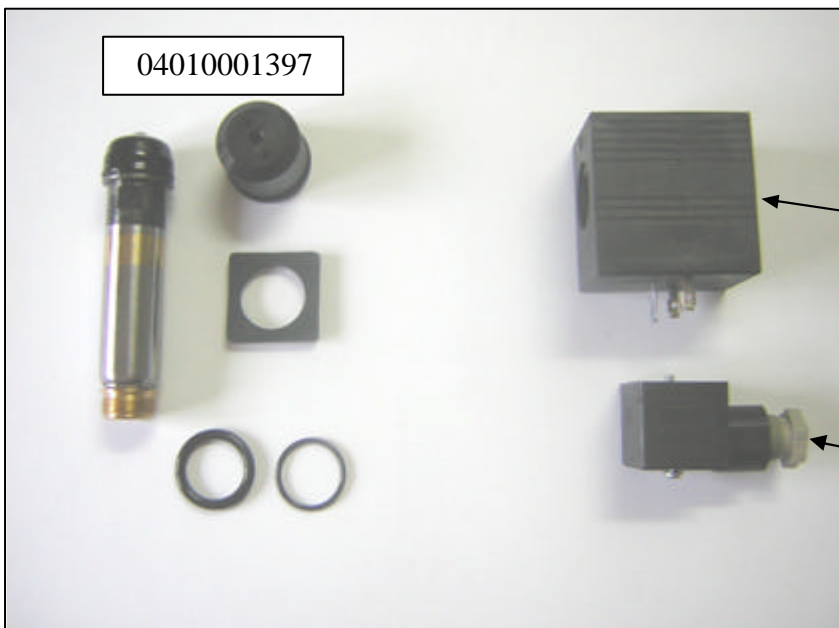
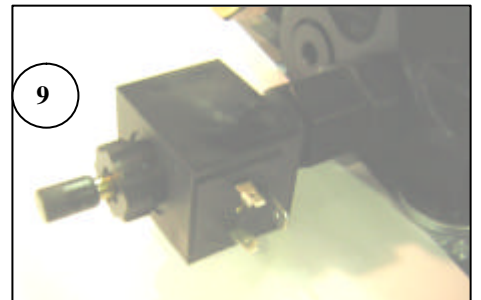
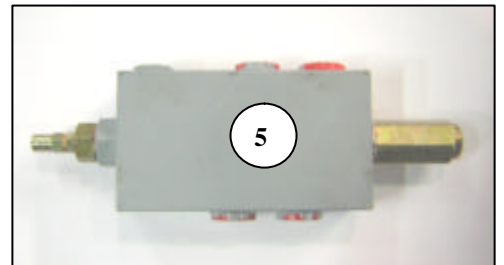
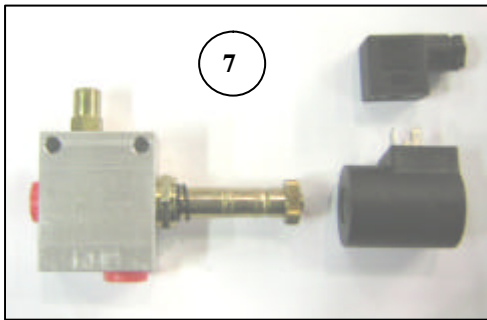
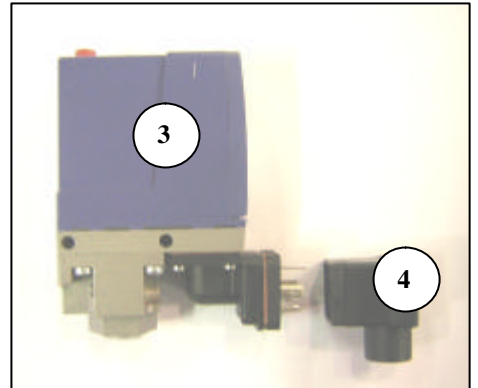
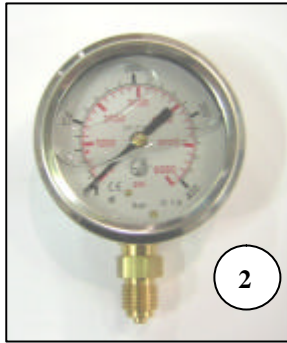
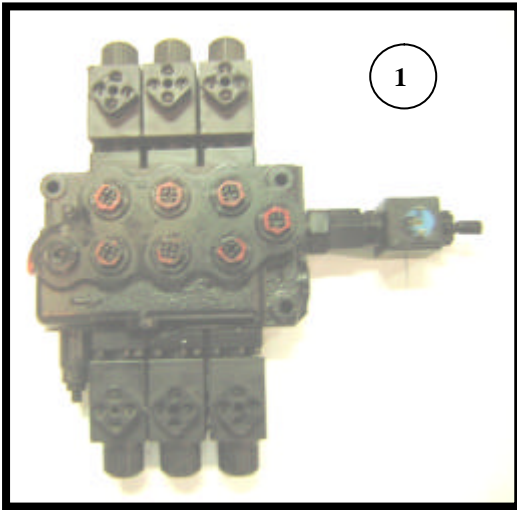

04010001397

12 VOLT - 04010001395
24 VOLT - 04010001396

05080001003

6

ELETTRICA

ELECTRIC

IN CABINA IN TO CABIN

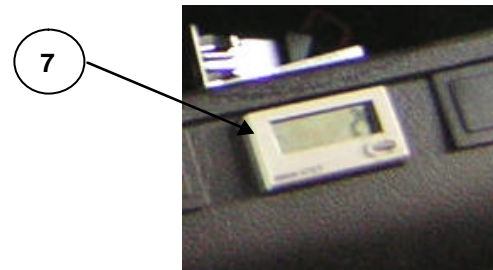
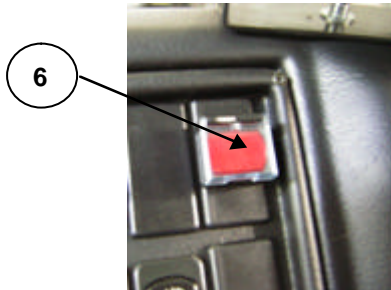
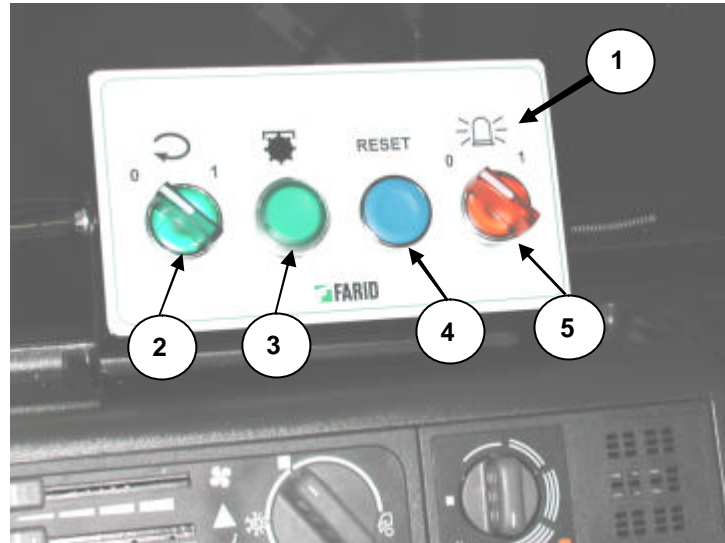

TAV.	POS	CODICE / CODE	DESCRIZIONE	DESCRIPTION	Q.TY	NOTE
T12	1	02100001584	SINOTTICO COMPLETO	CONTROL PANEL COMPLETE	1	24V - EL/ PNEUMATICO 24V ELECTRIC/PNEUMATIC COMPLETO-COMPLETE
T12	2	05020001419 05020001420 05020001421 05020001422	SELETTORE VERDE TESTA PORTALAMPADA CONTATTO NO	GREEN-SELECTOR HEAD SUPPORT-LAMP CONTACT NO	1 1 1 1	COMPLETO-COMPLETE
T12	3	05020001423 05020001424 05020001425	PULSANTE VERDE TESTA PORTALAMPADA + CONTATTO	GREEN-BUTTON HEAD SUPPORT-LAMP + CONTACT	1 1 1	COMPLETO-COMPLETE
T12	4	05020001426 05020001427 05020001428	PULSANTE BLU TESTA CONTATTO NO	BLUE-BUTTON HEAD CONTACT NO	1 1 1	COMPLETO-COMPLETE
T12	5	05020001432 05020001422 05020001433 05020001434	SELETTORE ARANCIO CONTATTO NO TESTA PORTALAMPADA	ORANGE-SELECTOR CONTACT NO HEAD SUPPORT-LAMP	1 1 1 1	COMPLETO-COMPLETE
T12	6	05010001512 05010001513 05010001514 05010001515 05010001516	PULSANTE BY-PASS PULSANTE - CORPO GEMMA ROSSA LED SPORTELLINO	BY-PASS BUTTON BUTTON - BODY RED GEM LED LITTLE DOOR	1 1 1 1 1	COMPLETO-COMPLETE
T12	7	05180001040	CONTAORE	HOURLMETER	1	

TAV .T12

FARID Industrie S.p.a.

SENSORI PALA
PACKER PLATE SENSORS

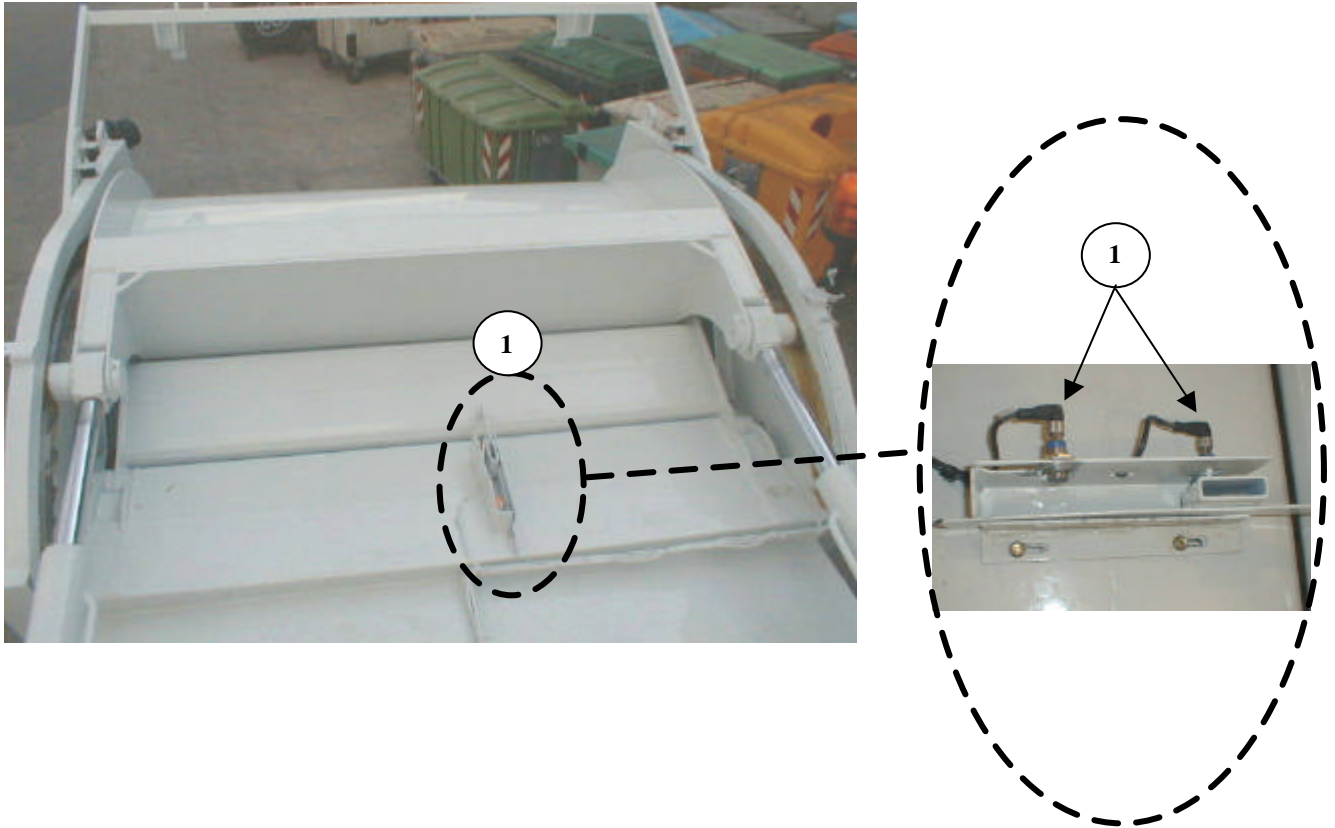

TAV	POS	CODICE / CODE	DESCRIZIONE	DESCRIPTION	Q.TY	NOTE
T13	1	05050001027	SENSORE	SENSOR	2	
		05080001050	CAVO - SENSORE	SENSOR - CABLE	2	CAVO Mt 5-CABLE Mt 5

SENSORI VOLTACONTENITORI BIN LIFT SENSORS

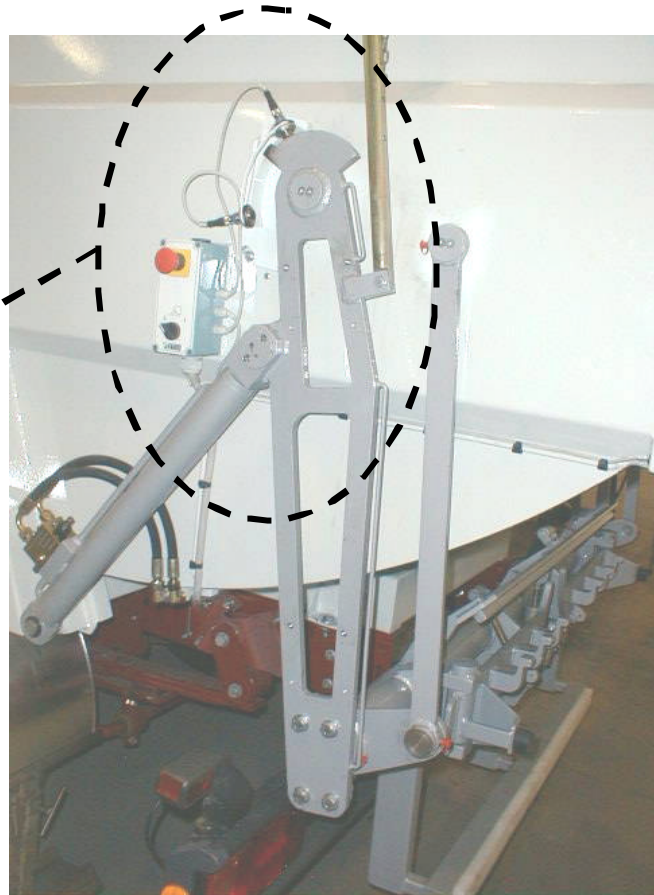
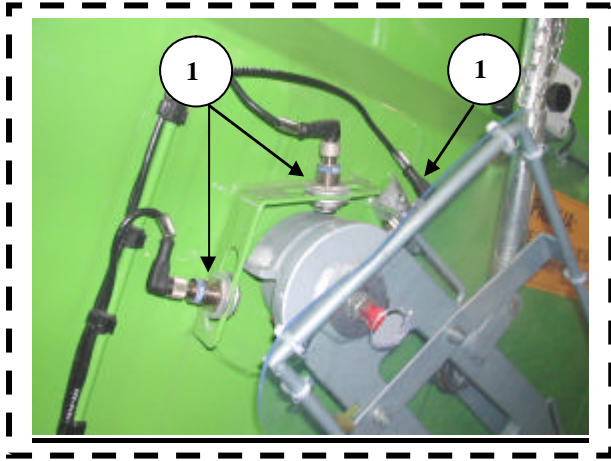

TAV	POS	CODICE / CODE	DESCRIZIONE	DESCRIPTION	Q.TY	NOTE
T14	1	05050001027	SENSORE	SENSOR	3	
		05080001050	CAVO - SENSORE	SENSOR-CABLE	3	CAVO Mt 5-CABLE Mt 5

SENSORE SPONDINA POSTERIORE REAR FLAP SENSOR

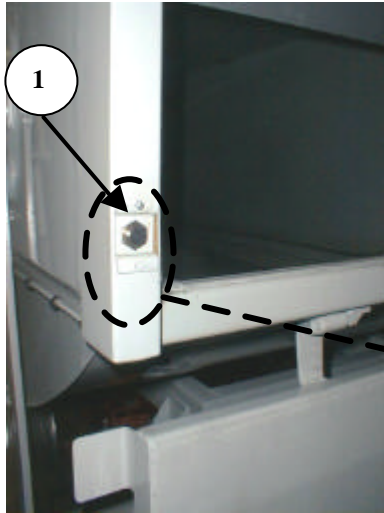

TAV	POS	CODICE / CODE	DESCRIZIONE	DESCRIPTION	Q.TY	NOTE
T15	1	05050001027	SENSORE	SENSOR	1	
		08260001197	SUPPORTO	SUPPORT	1	
		05080001050	CAVO	CABLE	1	

PULSANTIERA POSTERIORE DESTRA CONTROL BOX SIDE RIGHT (REAR)



TAV	POS	CODICE / CODE	DESCRIZIONE	DESCRIPTION	Q.TY	NOTE
T16	1	05020001022	PULSANTE VERDE	BUTTON-GREEN	1	
		05120001003	PORTALAMPADA	SUPPORT-LIGHT	1	
		05120001052	LAMPADINA 12V	LIGHT 12V	1	
		05120001061	LAMPADINA 24V	LIGHT 24V	1	
		05020001283	CONTATTO NO	CONTACT - NO	1	
		05020001284	CONTATTO NC	CONTACT - NC	1	
T16	2	05020001020	PULSANTE BLU	BUTTON - BLU	1	
		05020001018	CONTATTO NO	CONTACT NO	1	
T16	3	05020001021	PULSANTE GIALLO	BUTTON - YELLOW	1	
		05020001016	CONTATTO NC	CONTACT - NC	1	
T16	4	05020001020	PULSANTE BLU	BUTTON - BLU	1	
		05020001018	CONTATTO NO	CONTACT NO	1	
T16	5	05020001015	PULSANTE ROSSO	BUTTON - RED	1	
		05020001016	CONTATTO NC	CONTACT NC	1	
T16	6	05010001212	CONTENITORE	BOX	1	
T16		05010001327	PULSANTIERA COMPLETA	CONTROL BOX COMPLETE	1	

PULSANTIERA ANTERIORE DESTRA CONTROL BOX SIDE RIGHT (FRONT)

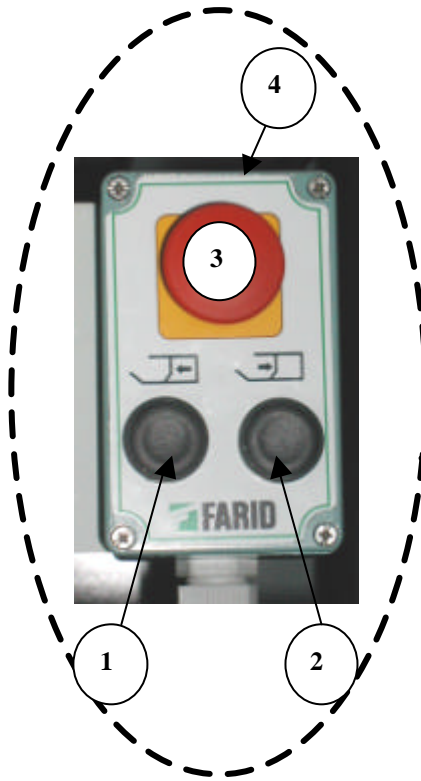

TAV	POS	CODICE / CODE	DESCRIZIONE	DESCRIPTION	Q.TY	NOTE
T17	1	05020001017	PULSANTE NERO	BUTTON-BLACK	1	
		05020001018	CONTATTO NO	CONTACT - NO	1	
T17	2	05020001017	PULSANTE NERO	BUTTON-BLACK	1	
		05020001018	CONTATTO NO	CONTACT - NO	1	
T17	3	05020001015	PULSANTE ROSSO	BUTTON - RED	1	
		05020001016	CONTATTO NC	CONTACT NC	1	
T17	4	05010001211	CONTENITORE	BOX	1	
T17		05010001325	PULSANTIERA COMPLETA	CONTROL BOX COMPLETE	1	

PULSANTIERA POSTERIORE SINISTRA
CONTROL BOX SIDE LEFT (REAR)

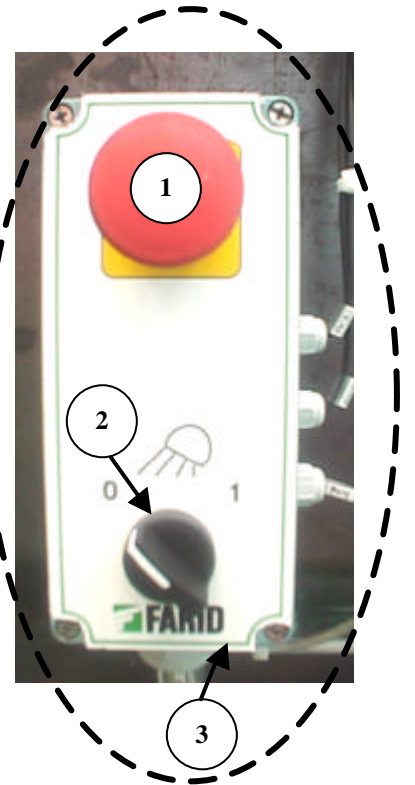

TAV	POS	CODICE / CODE	DESCRIZIONE	DESCRIPTION	Q.TY	NOTE
T18	1	05020001015	PULSANTE ROSSO	BUTTON - RED	1	
		05020001016	CONTATTO NC	CONTACT NC	1	
T18	2	05020001019	SELETTORE-NERO	SELECTOR-BLACK	1	
		05020001018	CONTATTO NO	CONTACT NO	1	
T18	3	05010001212	CONTENITORE	BOX	1	
T18		05010001326	PULSANTIERA COMPLETA	CONTROL BOX COMPLETE	1	

SCATOLA ELETTRICA
ELECTRIC BOX

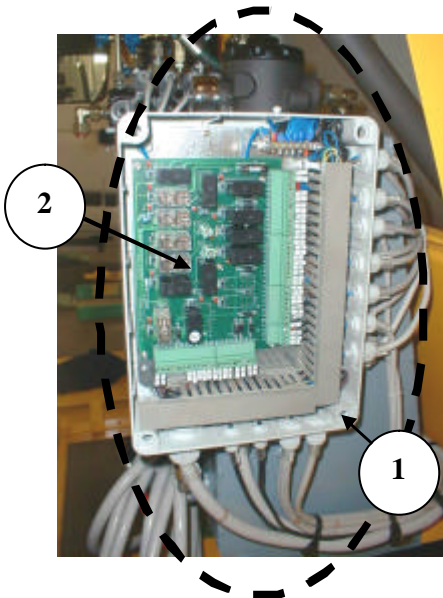

TAV	POS	CODICE / CODE	DESCRIZIONE	DESCRIPTION	Q.TY	NOTE
T19	1	05097000008	SCATOLA	BOX	1	

T19	2	02100001566	SCHEDA	CARD	1	24 VOLT PNEUMATICO-PNEUMATIC
		02100001565	SCHEDA	CARD	1	12 VOLT MECCANICO-MECHANIC

ACCESSORI ELETTRICI ELECTRIC ACCESSORIES

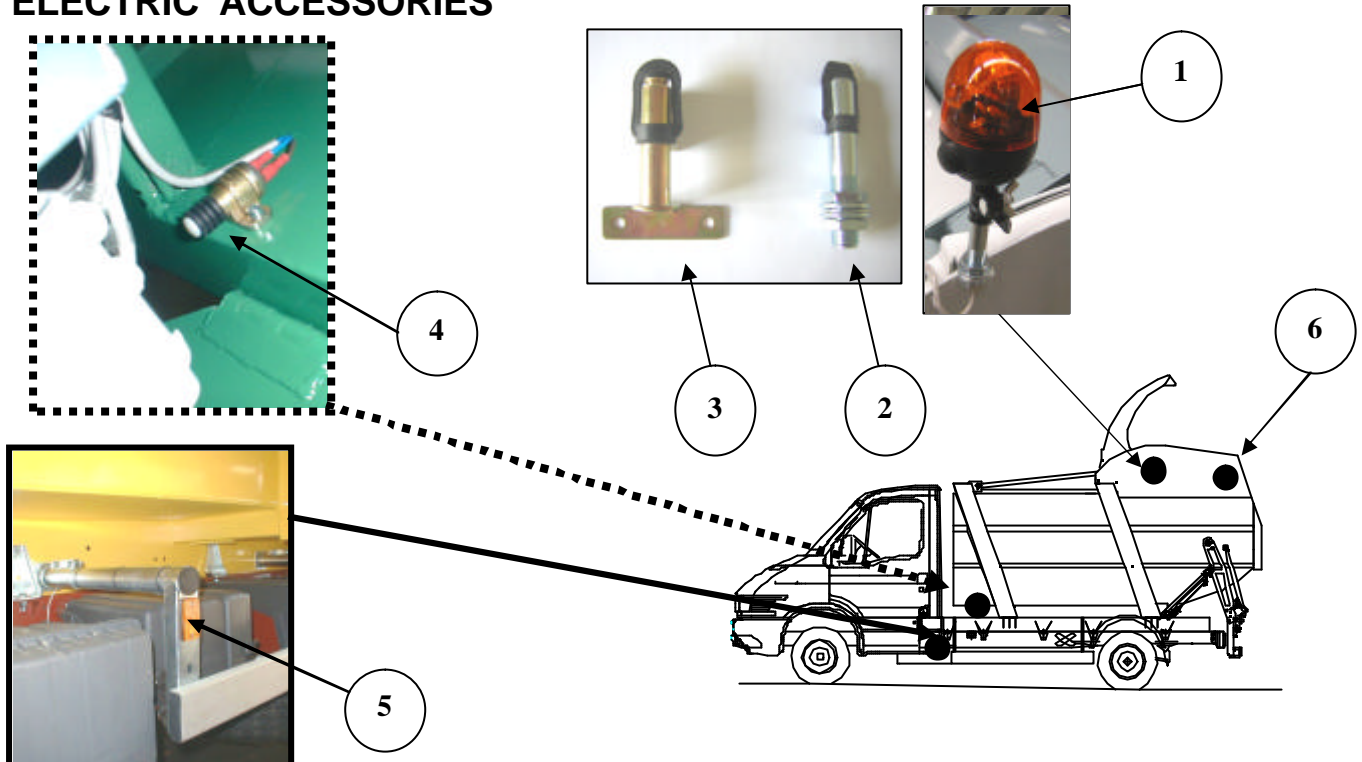

TAV	POS	CODICE / CODE	DESCRIZIONE	DESCRIPTION	Q.TY	NOTE
T21	1	05060001352	FARO ROTANTE 24 VOLT	ROTATION LAMP 24 VOLT	1	COMPLETO-COMLETE
T21						
T21	1	05060001354	FARO ROTANTE 12 VOLT	ROTATION LAMP 12 VOLT	1	COMPLETO-COMLETE
T21	1	05120001173	LAMPADINA 24V	LAMP 24 V	1	35 W
T21	1	05120001172	LAMPADINA 12V	LAMP 12 V	1	35 W
T21	1	05060001276	FARO FLASH 24 VOLT COMPLETO	FLASH LAMP 24 VOLT COMPLETE	1	OPTIONAL
T21	1	05060001280	FARO FLASH 12 VOLT COMPLETO	FLASH LAMP 12 VOLT COMPLETE	1	OPTIONAL
T21	2	05060001140	SUPPORTO DRITTO FARO	SUPPORT FOR ROTATION LAMP	1	
T21	3	05060001119	SUPPORTO " T " FARO	SUPPORT " T " ROTATION LAMP	1	
T21	4	05020001380	INTERRUTTORE SPORTELLI LATERALI	MICRO SWITCH LATERAL DOOR	2	OPTIONAL
T21	5	05060001265 05060001207 05060001232 08260001158	CATADIOTRO LAMPADINA 24 V LAMPADINA 12 V STAFFA PLASTICA	REFLECTING LAMP 24 V LAMP 12 V PLASTIC SUPPORT	/ / / /	

PAGINA 1 di 2
SHEET 1 of 2

**ACCESSORI ELETTRICI
ELECTRIC ACCESSORIES**

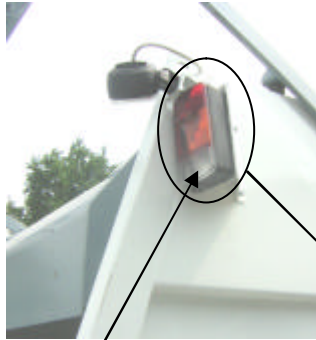

7



8

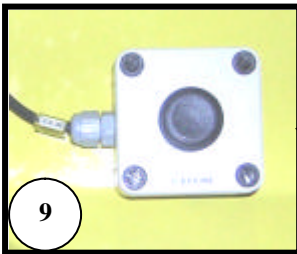
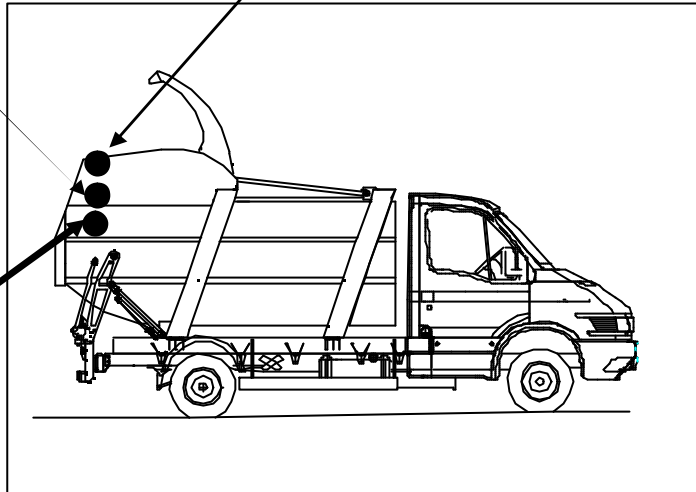

9

T21	6	05060001138	LUCE RIPETIZ. SIN. COMPLETO	LEFT LAMP COMPLETE	1	OPTIONAL
		05060001139	COPERTURE IN PLASTICA	PLASTIC COVER	1	
		08260001264	SUPPORTO	SUPPORT	1	
T21	7	05060001136	LUCE RIPETIZ. DEST. COMPLETO	RIGHT LAMP COMPLETE	1	OPTIONAL
		05060001137	COPERTURE IN PLASTICA	PLASTIC COVER	1	
		08260001264	SUPPORTO	SUPPORT	1	
T21		05120001065	LAMP. 24 V- 5/21W	LAMPS 24 V- 5/21W	2	
		05120001066	LAMP. 24 V- 21W	LAMP 24 V- 21W	2	
		05120001055	LAMP. 12V 5/21W	LAMPS 12 V- 5/21W	2	
		05120001054	LAMP. 12 V- 21W	LAMP 12 V- 21W	2	
T21	8	05060001262	FARO LAVORO	WORKING LIGHT	1	
T21		05120001069	LAMPADINA – 24 V 70 W	LAMP – 24 VOLT 70 W	1	
T21		05120001058	LAMPADINA – 12 V 55 W	LAMP – 12 VOLT 55 W	1	
T21	9	02100001880	SUONERIA ESTERNA	BUZZER	2	OPTIONAL

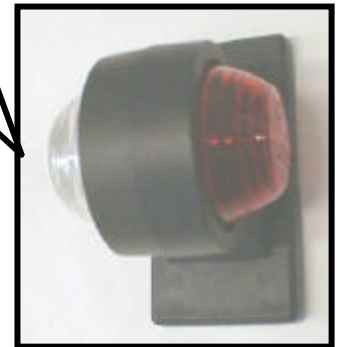
ACCESSORI ELETTRICI
ELECTRIC ACCESSORIES

1

TAB	POS	CODICE-CODE	DESCRIZIONE	DESCRIPTION	Q.TY	NOTE
T21A	1	05060001164	LUCE INGOMBRO	ESTERNAL SIDE MARKER	2	
		05120001063	LAMPADINA 24 V - 5W	LAMP 24 V - 5W	2	
		05120001053	LAMPADINA 12 V - 5W	LAMP 12 V - 5W	2	

**FINECORSA PARATIA ESPULSIONE
MICRO SWITCH EJECTION PLATE**

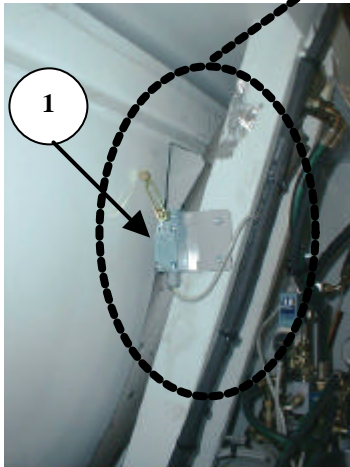

TAV	POS	CODICE / CODE	DESCRIZIONE	DESCRIPTION	Q.TY	NOTE
T26	1	05050001219	FINECORSA	MICRO SWITCH	1	COMPLETO COMPLETE
T26	2	05020001242	ASTA	LEVER	1	